

FEATURES

- Double Side Cooling
- High Surge Capability

KEY PARAMETERS

V_{RRM}	4000V
$I_{F(AV)}$	4346A
I_{FSM}	83000A

APPLICATIONS

- Rectification
- Free-wheel Diode
- DC Motor Control
- Power Supplies
- Welding
- Battery Chargers

VOLTAGE RATINGS

Part and Ordering Number	Repetitive Peak Voltages V_{DRM} and V_{DRM} V	Conditions
DRD4350A40	4000	$V_{RSM} = V_{RRM} + 100V$
DRD4350A39	3900	
DRD4350A38	3800	
DRD4350A37	3700	
DRD4350A36	3600	
DRD4350A35	3500	

Lower voltage grades available.

ORDERING INFORMATION

When ordering, select the required part number shown in the Voltage Ratings selection table.

For example:

DRD4350A39

Note: Please use the complete part number when ordering and quote this number in any future correspondence relating to your order.

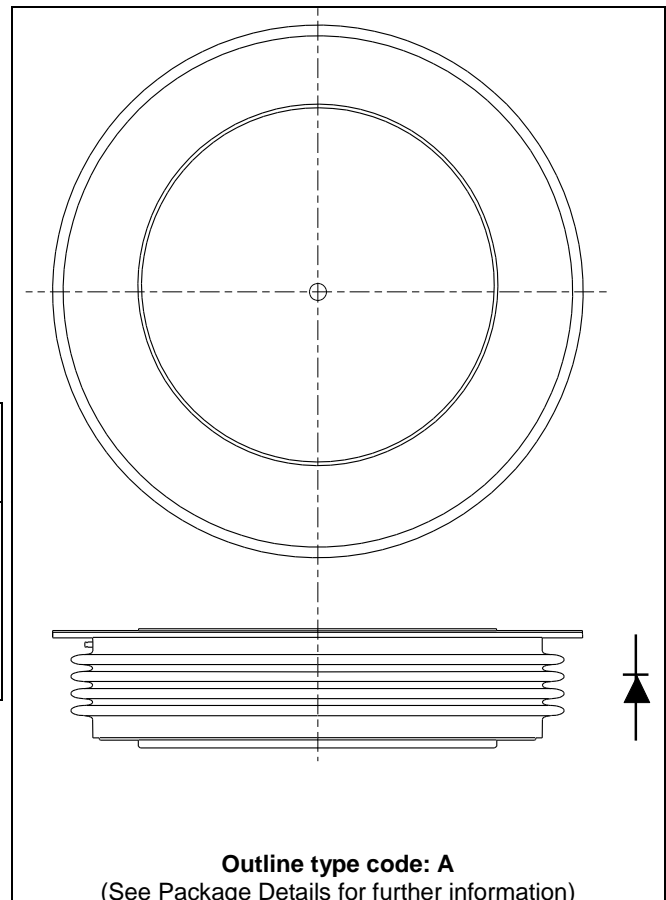

Fig. 1 Package outlines

CURRENT RATINGS
T_{case} = 75°C unless stated otherwise

Symbol	Parameter	Test Conditions	Max.	Units
Double Side Cooled				
I _{F(AV)}	Mean forward current	Half wave resistive load	5651	A
I _{F(RMS)}	RMS value	-	8877	A
I _F	Continuous (direct) on-state current	-	8208	A
Single Side Cooled (Anode side)				
I _{F(AV)}	Mean forward current	Half wave resistive load	3707	A
I _{F(RMS)}	RMS value	-	5821	A
I _F	Continuous (direct) on-state current	-	4976	A

T_{case} = 100°C unless stated otherwise

Symbol	Parameter	Test Conditions	Max.	Units
Double Side Cooled				
I _{F(AV)}	Mean forward current	Half wave resistive load	4350	A
I _{F(RMS)}	RMS value	-	6830	A
I _F	Continuous (direct) on-state current	-	6160	A
Single Side Cooled (Anode side)				
I _{F(AV)}	Mean forward current	Half wave resistive load	2795	A
I _{F(RMS)}	RMS value	-	4390	A
I _F	Continuous (direct) on-state current	-	3640	A

SURGE RATINGS

Symbol	Parameter	Test Conditions	Max.	Units
I_{FSM}	Surge (non-repetitive) on-state current	10ms half sine, $T_{case} = 150^{\circ}C$ $V_R = 50\% V_{RRM} - \frac{1}{4}$ sine	66.5	kA
I^2t	I^2t for fusing		22	MA ² s
I_{FSM}	Surge (non-repetitive) on-state current	10ms half sine, $T_{case} = 150^{\circ}C$ $V_R = 0$	83	kA
I^2t	I^2t for fusing		34.5	MA ² s

THERMAL AND MECHANICAL RATINGS

Symbol	Parameter	Test Conditions	Min.	Max.	Units	
$R_{th(j-c)}$	Thermal resistance – junction to case	Double side cooled	DC	-	0.0065	$^{\circ}C/W$
		Single side cooled	Anode DC	-	0.013	$^{\circ}C/W$
			Cathode DC	-	0.013	$^{\circ}C/W$
$R_{th(c-h)}$	Thermal resistance – case to heatsink	Clamping force 83.0kN (with mounting compound)	Double side	-	0.001	$^{\circ}C/W$
			Single side	-	0.002	$^{\circ}C/W$
T_{vj}	Virtual junction temperature	On-state (conducting)		-	160	$^{\circ}C$
		Reverse (blocking)		-	150	$^{\circ}C$
T_{stg}	Storage temperature range		-55	150	$^{\circ}C$	
F_m	Clamping force		75.0	91.0	kN	

CHARACTERISTICS

Symbol	Parameter	Test Conditions	Min.	Max.	Units
V_{FM}	Forward voltage	At 3000A peak, $T_{case} = 25^{\circ}C$	-	1.06	V
I_{RM}	Peak reverse current	At V_{DRM} , $T_{case} = 150^{\circ}C$	-	400	mA
V_{TO}	Threshold voltage	At $T_{vj} = 150^{\circ}C$	-	0.78	V
r_T	Slope resistance	At $T_{vj} = 150^{\circ}C$	-	0.0763	m Ω

CURVES

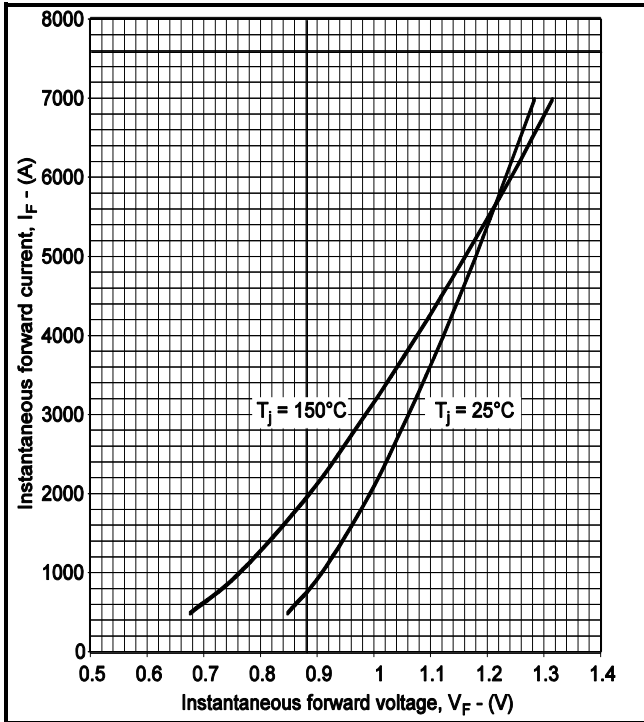

Fig.2 Maximum (limit) forward characteristics

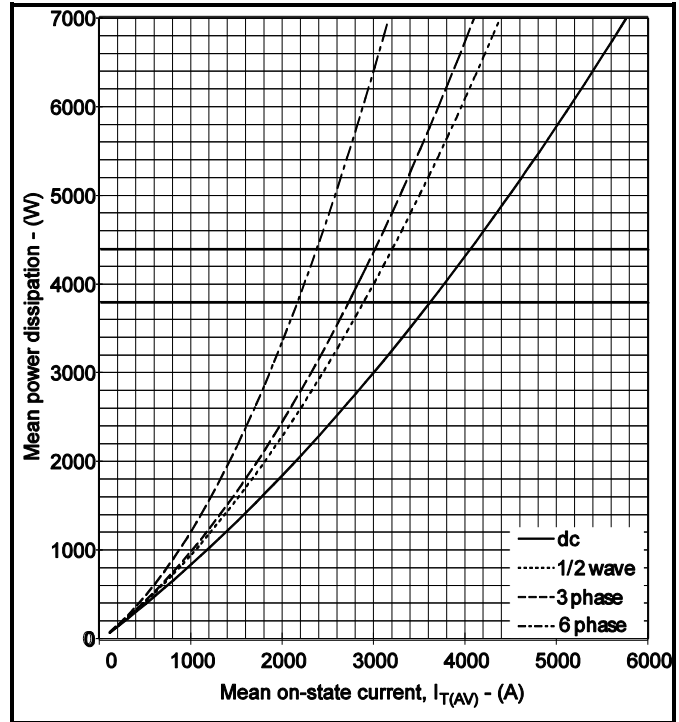

Fig.3 Power loss curves

V_{TM} EQUATION

$$V_{TM} = A + B \ln(I_T) + C \cdot I_T + D \cdot \sqrt{I_T}$$

Where $A = -0.01591$
 $B = 0.113682$
 $C = 8.04 \times 10^{-5}$
 $D = -0.00284$

these values are valid for $T_j = 150^\circ\text{C}$ for I_F 500A to 7000A

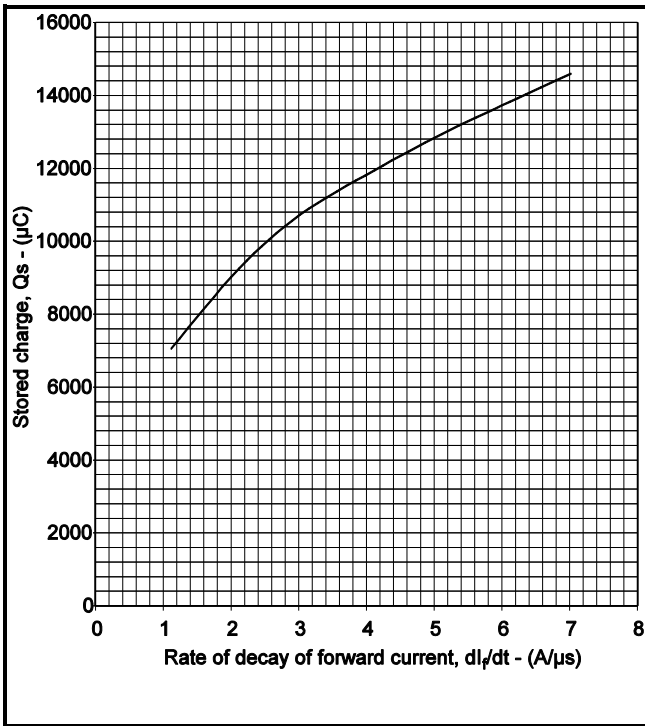

Fig.4 Stored charge

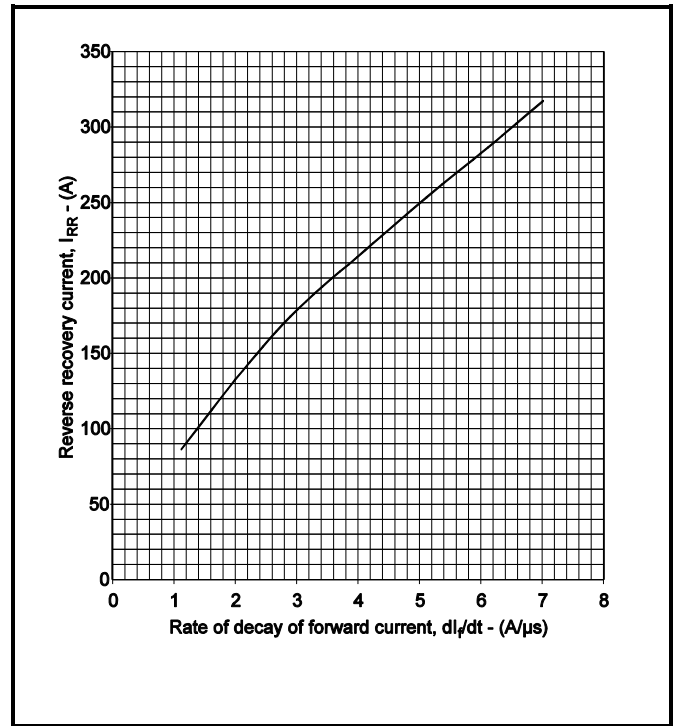

Fig.5 Reverse recovery current

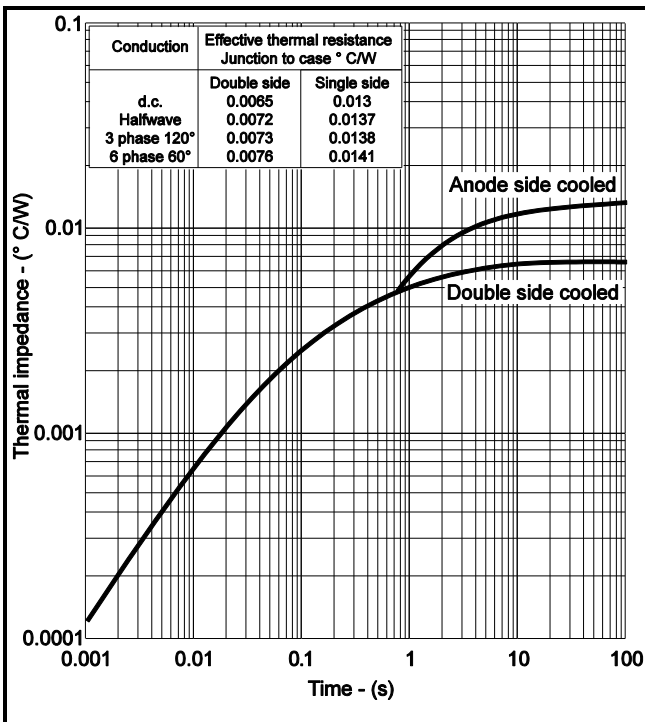

Fig.6 Maximum (limit) transient thermal impedance – junction to case

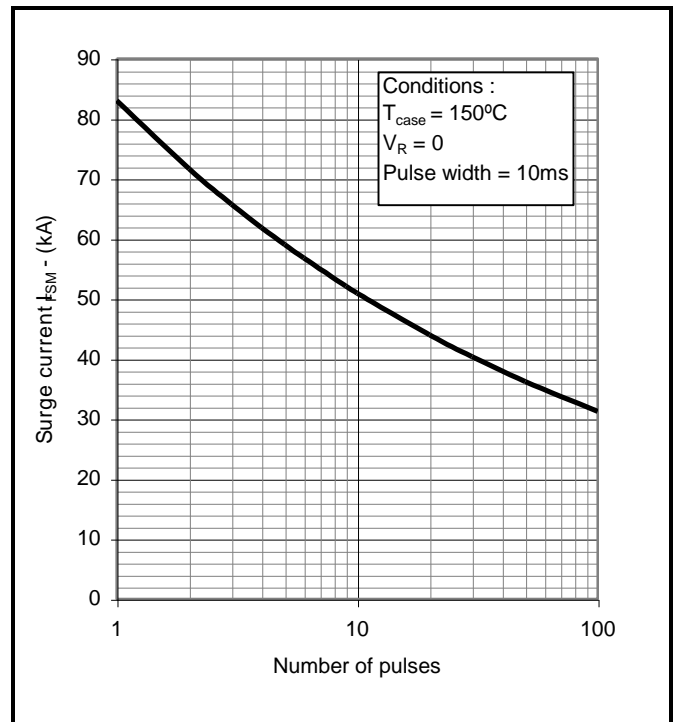

Fig.7 Multi-cycle surge current

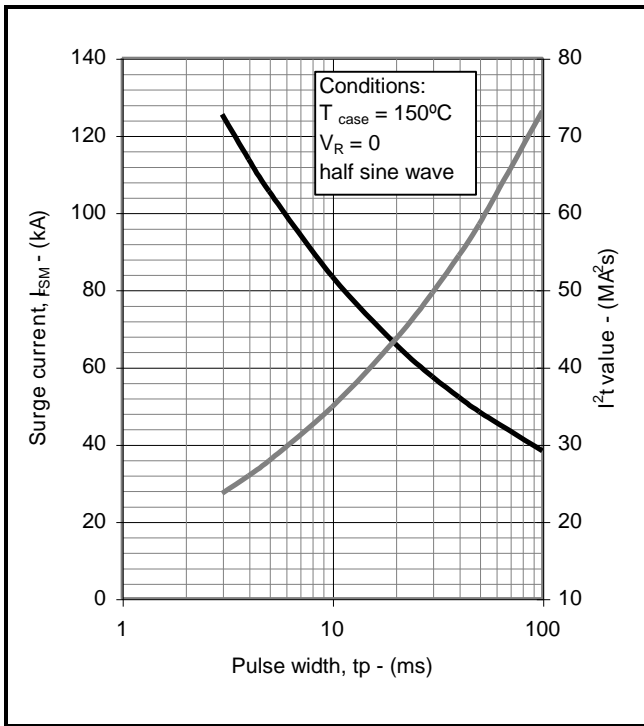
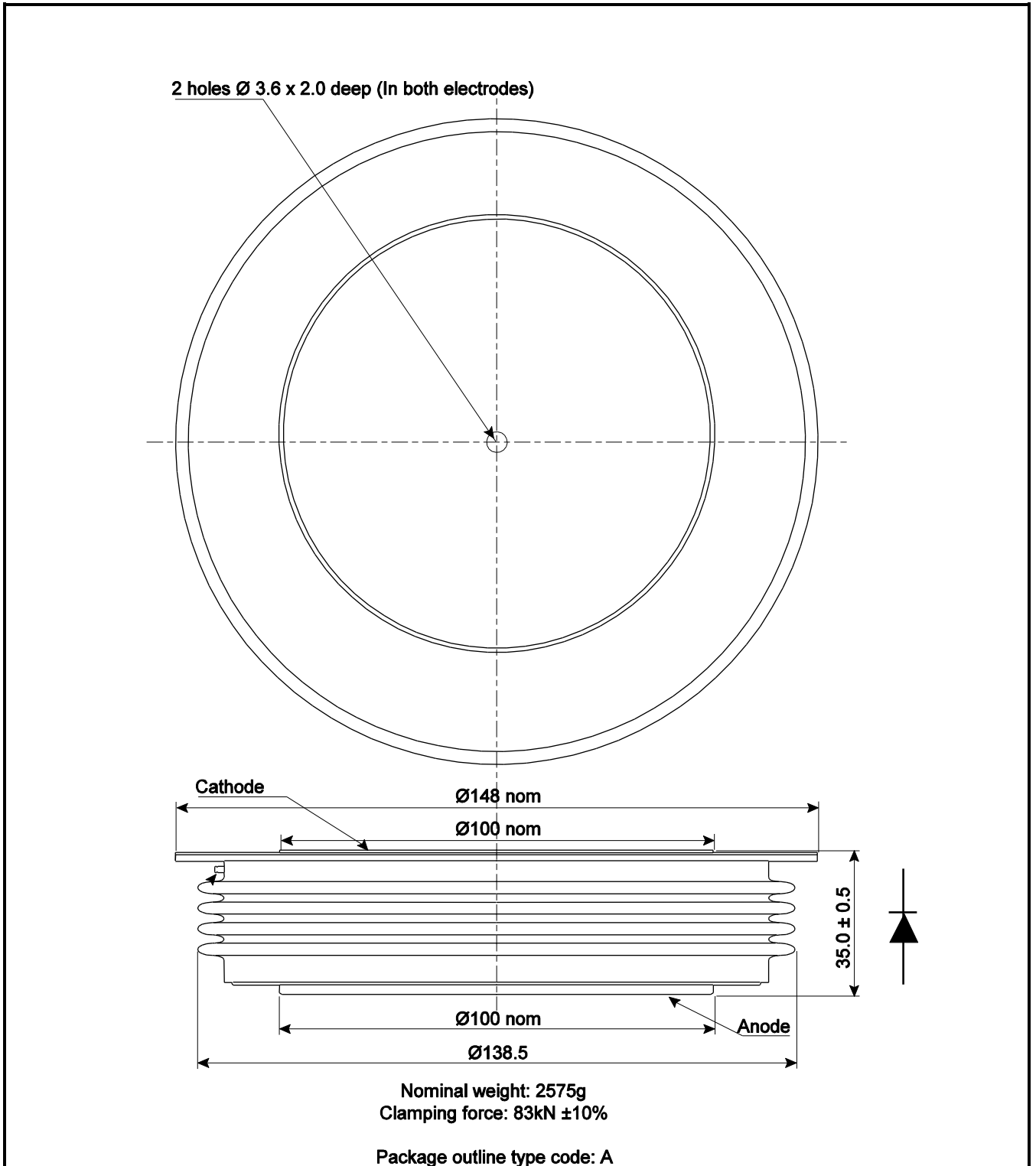

Fig.8 Sub-cycle surge current

PACKAGE DETAILS

For further package information, please contact Customer Services. All dimensions in mm, unless stated otherwise. DO NOT SCALE.



IMPORTANT INFORMATION:

This publication is provided for information only and not for resale.

The products and information in this publication are intended for use by appropriately trained technical personnel.

Due to the diversity of product applications, the information contained herein is provided as a general guide only and does not constitute any guarantee of suitability for use in a specific application. The user must evaluate the suitability of the product and the completeness of the product data for the application. The user is responsible for product selection and ensuring all safety and any warning requirements are met. Should additional product information be needed please contact Customer Service.

Although we have endeavoured to carefully compile the information in this publication it may contain inaccuracies or typographical errors. The information is provided without any warranty or guarantee of any kind.

This publication is an uncontrolled document and is subject to change without notice. When referring to it please ensure that it is the most up to date version and has not been superseded.

The products are not intended for use in applications where a failure or malfunction may cause loss of life, injury or damage to property. The user must ensure that appropriate safety precautions are taken to prevent or mitigate the consequences of a product failure or malfunction.

The products must not be touched when operating because there is a danger of electrocution or severe burning. Always use protective safety equipment such as appropriate shields for the product and wear safety glasses. Even when disconnected any electric charge remaining in the product must be discharged and allowed to cool before safe handling using protective gloves.

Extended exposure to conditions outside the product ratings may affect reliability leading to premature product failure. Use outside the product ratings is likely to cause permanent damage to the product. In extreme conditions, as with all semiconductors, this may include potentially hazardous rupture, a large current to flow or high voltage arcing, resulting in fire or explosion. Appropriate application design and safety precautions should always be followed to protect persons and property.

Product Status & Product Ordering:

We annotate datasheets in the top right hand corner of the front page, to indicate product status if it is not yet fully approved for production. The annotations are as follows:-

Target Information:	This is the most tentative form of information and represents a very preliminary specification. No actual design work on the product has been started.
Preliminary Information:	The product design is complete and final characterisation for volume production is in progress. The datasheet represents the product as it is now understood but details may change.
No Annotation:	The product has been approved for production and unless otherwise notified by Dynex any product ordered will be supplied to the current version of the data sheet prevailing at the time of our order acknowledgement.

All products and materials are sold and services provided subject to Dynex's conditions of sale, which are available on request.

Any brand names and product names used in this publication are trademarks, registered trademarks or trade names of their respective owners.

HEADQUARTERS OPERATIONS

DYNEX SEMICONDUCTOR LIMITED
Doddington Road, Lincoln, Lincolnshire, LN6 3LF
United Kingdom.
Phone: +44 (0) 1522 500500
Fax: +44 (0) 1522 500550
Web: <http://www.dynexsemi.com>

CUSTOMER SERVICE

Phone: +44 (0) 1522 502753 / 502901
Fax: +44 (0) 1522 500020
e-mail: power_solutions@dynexsemi.com