

FEATURES

- Trench Gate IGBT
- Cu Base with Enhanced Al₂O₃ Substrates
- High Thermal Cycling Capability
- 10µs Short Circuit Withstand
- Low E_{ON} E_{OFF} Variant
- IGBT T_{vj(max)} = 175°C

APPLICATIONS

- Motor Drives
- Power Charging Equipment
- Renewable Energy Power Conversion
- Electric Vehicles

The Powerline range of high power modules includes half bridge, chopper, dual, single and bi-directional switch configurations covering voltages from 1200V to 6500V and currents up to 2400A.

The DIM600M1HS12-PC500 is a half bridge 1200V, trench gate, insulated gate bipolar transistor (IGBT) module with enhanced field stop and implantation technology. The IGBT has a wide reverse bias safe operating area (RBSOA) plus 10µs short circuit withstand. This device is optimised for traction drives and other applications requiring high thermal cycling capability.

The module incorporates an electrically isolated base plate and low inductance construction enabling circuit designers to optimise circuit layouts and utilise grounded heat sinks for safety.

ORDERING INFORMATION

Order As:

DIM600M1HS12-PC500

Note: When ordering, please use the complete part number

KEY PARAMETERS

V _{CES}	1200V
V _{CE(sat)} * (typ)	1.85V
I _C (max)	600A
I _{C(PK)} (max)	1200A

* Measured at the auxiliary terminals

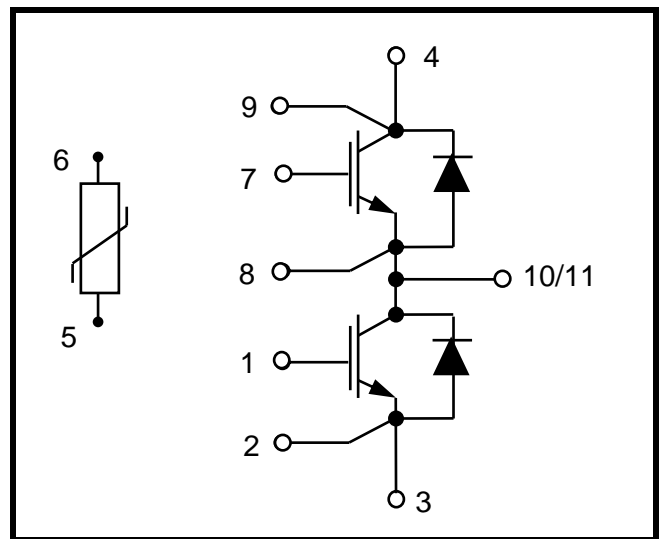

Fig. 1 Circuit configuration



Outline type code: M1
(See Fig. 15 for further information)

Fig. 2 Package

ABSOLUTE MAXIMUM RATINGS

Stresses above those listed under ‘Absolute Maximum Ratings’ may cause permanent damage to the device. In extreme conditions, as with all semiconductors, this may include potentially hazardous rupture of the package. Appropriate safety precautions should always be followed. Exposure to Absolute Maximum Ratings may affect device reliability.

T_{case} = 25°C unless stated otherwise

Symbol	Parameter	Test Conditions	Max.	Units
V _{CES}	Collector-emitter voltage	V _{GE} = 0V, T _C = 25°C	1200	V
V _{GES}	Gate-emitter voltage	T _C = 25°C	±20	V
I _C	Continuous collector current	T _C = 100 °C, T _{vj} max = 175°C	600	A
I _{C(PK)}	Peak collector current	t _P = 1ms, T _C = 133°C	1200	A
P _{max}	Max. transistor power dissipation	T _C = 25°C, T _{vj} = 175°C	3.0	kW
I ² t	Diode I ² t value	V _R = 0, t _p = 10ms, T _{vj} = 150°C	21.6	kA ² s
V _{isol}	Isolation voltage – per module	Commoned terminals to base plate. AC RMS, 1 min, 50Hz	2500	V

THERMAL AND MECHANICAL RATINGS

Internal insulation material:	Al ₂ O ₃
Baseplate material:	Cu
Creepage distance – Terminal to heatsink:	14.5mm
Creepage distance – Terminal to terminal:	13.0mm
Clearance – Terminal to heatsink:	12.5mm
Clearance – Terminal to terminal:	10mm
CTI (Comparative Tracking Index):	>200

Symbol	Parameter	Test Conditions	Min	Typ.	Max	Units
R _{th(j-c)}	Thermal resistance – IGBT	Continuous dissipation - junction to case	-	-	49	°C/kW
R _{th(j-c)}	Thermal resistance – diode		-	-	77	°C/kW
R _{th(c-h)}	Thermal resistance – case to heatsink (IGBT)	Mounting torque 5Nm (with mounting grease 1W/m °C)	-	-	34	°C/kW
R _{th(c-h)}	Thermal resistance – case to heatsink (Diode)		-	-	40	°C/kW
T _j	Junction temperature	IGBT	-40	-	150	°C
		Diode	-40	-	150	°C
T _{stg}	Storage temperature range	-	-40	-	125	°C
	Screw torque	Mounting – M5	3	-	6	Nm
		Electrical connections – M6	3	-	6	Nm

ELECTRICAL CHARACTERISTICS

$T_{case} = 25^{\circ}\text{C}$ unless stated otherwise.

Symbol	Parameter	Test Conditions	Min	Typ	Max	Units
I _{CES}	Collector cut-off current	V _{GE} = 0V, V _{CE} = V _{CES}			1	mA
		V _{GE} = 0V, V _{CE} = V _{CES} , T _C = 125°C			10	mA
		V _{GE} = 0V, V _{CE} = V _{CES} , T _C = 150°C			20	mA
I _{GES}	Gate leakage current	V _{GE} = ± 20V, V _{CE} = 0V			0.5	μA
V _{GE(TH)}	Gate threshold voltage	I _C = 15mA, V _{GE} = V _{CE}	5.50	6.10	6.70	V
V _{CE(sat)}	Collector-emitter saturation voltage	V _{GE} = 15V, I _C = 600A		1.85	2.25	V
		V _{GE} = 15V, I _C = 600A, T _j = 125°C		2.15	2.55	V
		V _{GE} = 15V, I _C = 600A, T _j = 150°C		2.25	2.65	V
I _F	Diode forward current	DC		600		A
I _{FM}	Diode maximum forward current	t _p = 1ms		1200		A
V _F	Diode forward voltage	I _F = 600A		1.9	2.3	V
		I _F = 600A, T _j = 125°C		2.1	2.5	V
		I _F = 600A, T _j = 150°C		2.1	2.5	V
C _{ies}	Input capacitance	V _{CE} = 25V, V _{GE} = 0V, f = 100kHz		93		nF
Q _g	Gate charge	±15V		6.9		μC
C _{res}	Reverse transfer capacitance	V _{CE} = 25V, V _{GE} = 0V, f = 1MHz		1.0		nF
L _M	Module inductance			22		nH
R _{INT}	Internal transistor resistance			1		mΩ
SC _{Data}	Short circuit current, I _{SC}	T _j = 150°C, V _{CC} = 800V t _p ≤ 10μs, V _{GE} ≤ 15V V _{CE(max)} = V _{CES} - L* x di/dt IEC 60747-9		2800		A

Note:

* L is the circuit inductance + L_M

NTC-Thermistor Data

Symbol	Parameter	Test Conditions	Min	Typ	Max	Units
R ₂₅	Rated resistance	T _C = 25°C		5		kΩ
ΔR/R	Deviation of R ₁₀₀	T _C = 100°C, R ₁₀₀ = 493Ω	-5		5	%
P ₂₅	Power dissipation	T _C = 25°C			20	mW
B _{25/50}	B-value	R ₂ = R ₂₅ exp [B _{25/50} (1/T ₂ - 1/(298.15K))]		3375		K
B _{25/80}		R ₂ = R ₂₅ exp [B _{25/80} (1/T ₂ - 1/(298.15K))]		3411		K
B _{25/100}		R ₂ = R ₂₅ exp [B _{25/100} (1/T ₂ - 1/(298.15K))]		3433		K

Caution: This device is sensitive to electrostatic discharge. Users should follow ESD handling procedures

ELECTRICAL CHARACTERISTICS

T_{case} = 25°C unless stated otherwise

Symbol	Parameter	Test Conditions		Min	Typ.	Max	Units
t _{d(off)}	Turn-off delay time	I _C = 600A V _{CE} = 600V V _{GE} = ±15V R _{G(OFF)} = 1.5Ω R _{G(ON)} = 1.5Ω L _S ~ 60nH	dv/dt = 5000V/μs		725		ns
t _f	Fall time				120		ns
E _{OFF}	Turn-off energy loss				66		mJ
t _{d(on)}	Turn-on delay time		di/dt = 6100A/μs		310		ns
t _r	Rise time				110		ns
E _{ON}	Turn-on energy loss				22		mJ
Q _{rr}	Diode reverse recovery charge	I _F = 600A V _{CE} = 600V di/dt = 6100A/μs			62		μC
I _{rr}	Diode reverse recovery current				405		A
E _{rec}	Diode reverse recovery energy				34		mJ

T_{case} = 125°C unless stated otherwise

Symbol	Parameter	Test Conditions		Min	Typ.	Max	Units
t _{d(off)}	Turn-off delay time	I _C = 600A V _{CE} = 600V V _{GE} = ±15V R _{G(OFF)} = 1.5Ω R _{G(ON)} = 1.5Ω L _S ~ 60nH	dv/dt = 5000V/μs		770		ns
t _f	Fall time				205		ns
E _{OFF}	Turn-off energy loss				80		mJ
t _{d(on)}	Turn-on delay time		di/dt = 6100A/μs		330		ns
t _r	Rise time				115		ns
E _{ON}	Turn-on energy loss				29		mJ
Q _{rr}	Diode reverse recovery charge	I _F = 600A V _{CE} = 600V di/dt = 6100A/μs			95		μC
I _{rr}	Diode reverse recovery current				460		A
E _{rec}	Diode reverse recovery energy				48		mJ

T_{case} = 150°C unless stated otherwise

Symbol	Parameter	Test Conditions		Min	Typ.	Max	Units
t _{d(off)}	Turn-off delay time	I _C = 600A V _{CE} = 600V V _{GE} = ±15V R _{G(OFF)} = 1.5Ω R _{G(ON)} = 1.5Ω L _S ~ 60nH	dv/dt = 5000V/μs		785		ns
t _f	Fall time				225		ns
E _{OFF}	Turn-off energy loss				84		mJ
t _{d(on)}	Turn-on delay time		di/dt = 6100A/μs		335		ns
t _r	Rise time				115		ns
E _{ON}	Turn-on energy loss				31		mJ
Q _{rr}	Diode reverse recovery charge	I _F = 600A V _{CE} = 600V di/dt = 6100A/μs			110		μC
I _{rr}	Diode reverse recovery current				490		A
E _{rec}	Diode reverse recovery energy				56		mJ

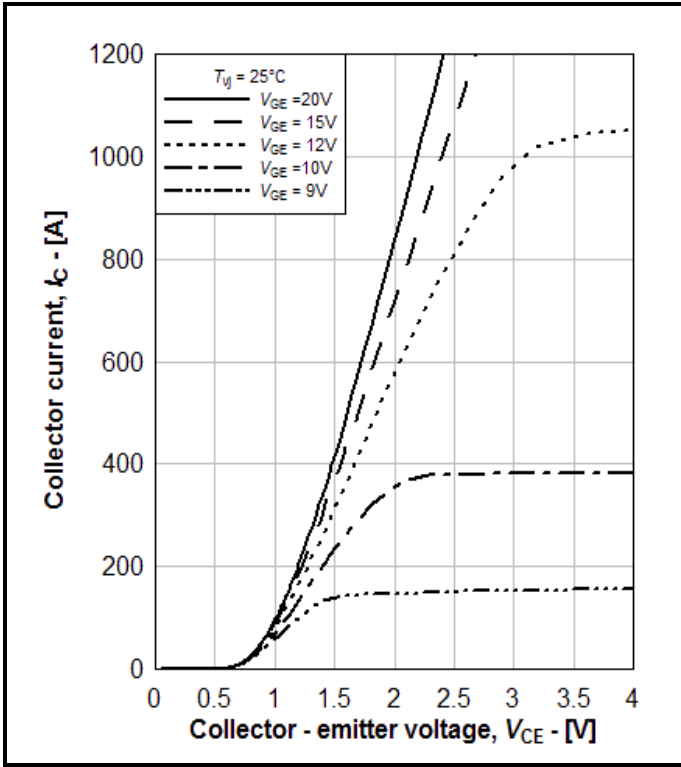

Fig. 3 Typical IGBT output characteristics, $I_c = f(V_{CE})$

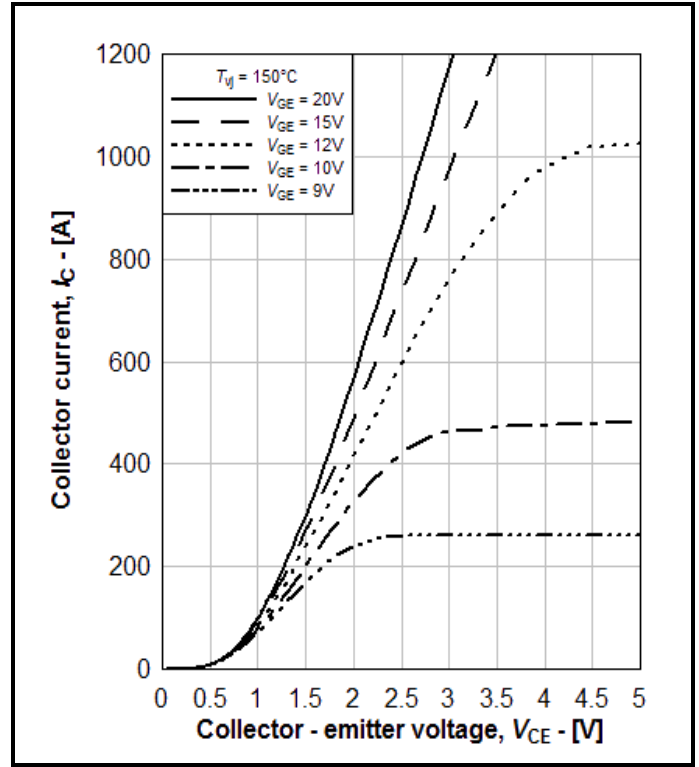

Fig. 4 Typical IGBT output characteristics, $I_c = f(V_{CE})$

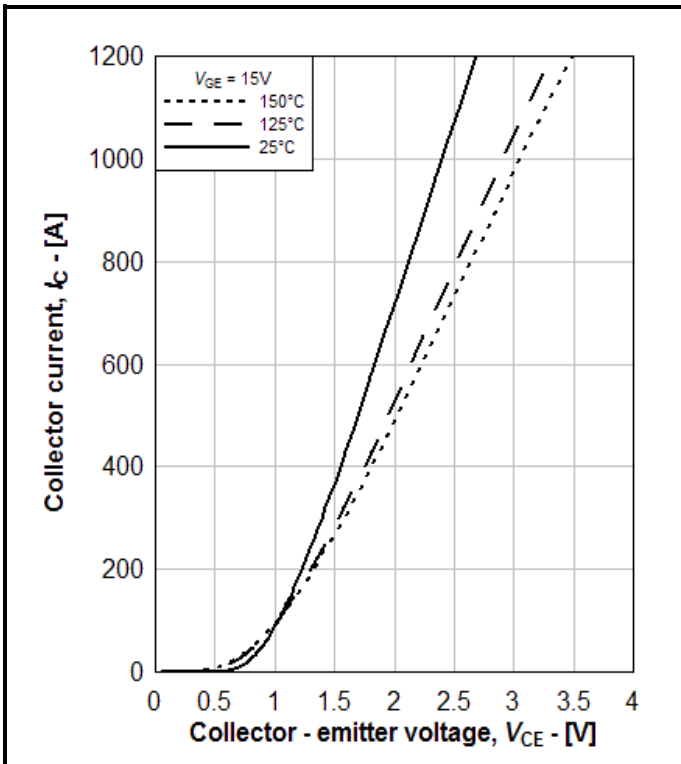

Fig. 5 Typical IGBT output characteristics, $I_c = f(V_{CE})$

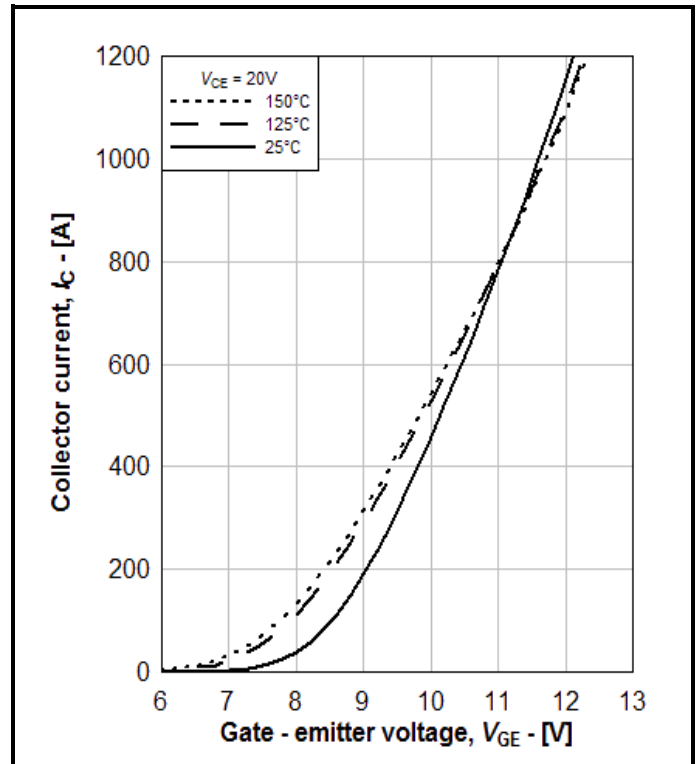

Fig. 6 Typical IGBT transfer characteristics, $I_c = f(V_{GE})$

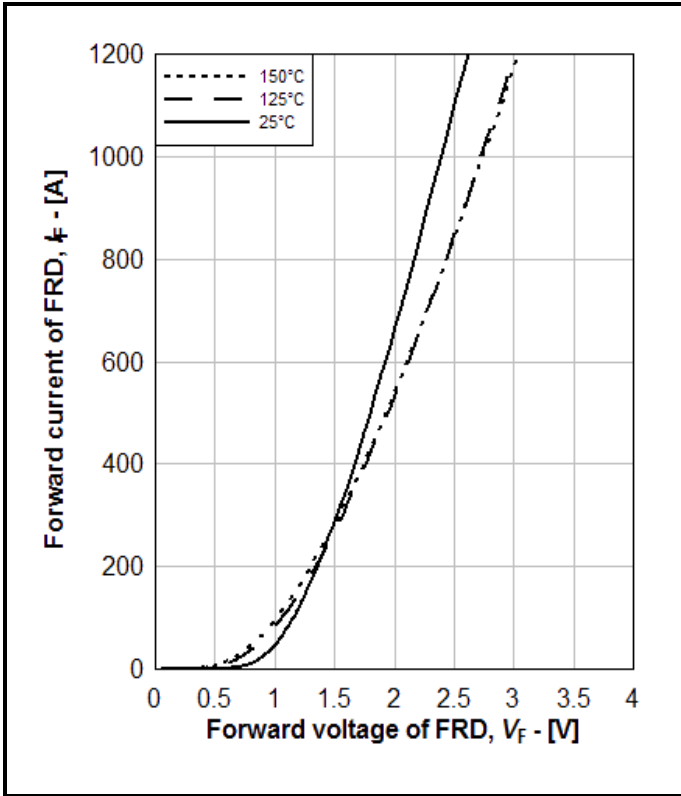

Fig. 7 Diode typical forward characteristics, $I_F = f(V_F)$

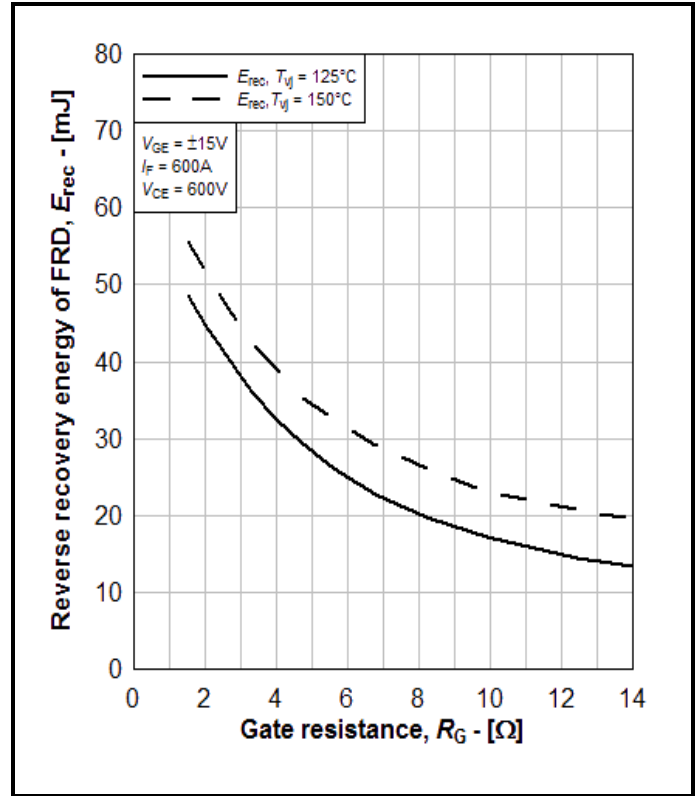

Fig. 8 Typical FRD E_{rec} , $E_{rec} = f(R_G)$

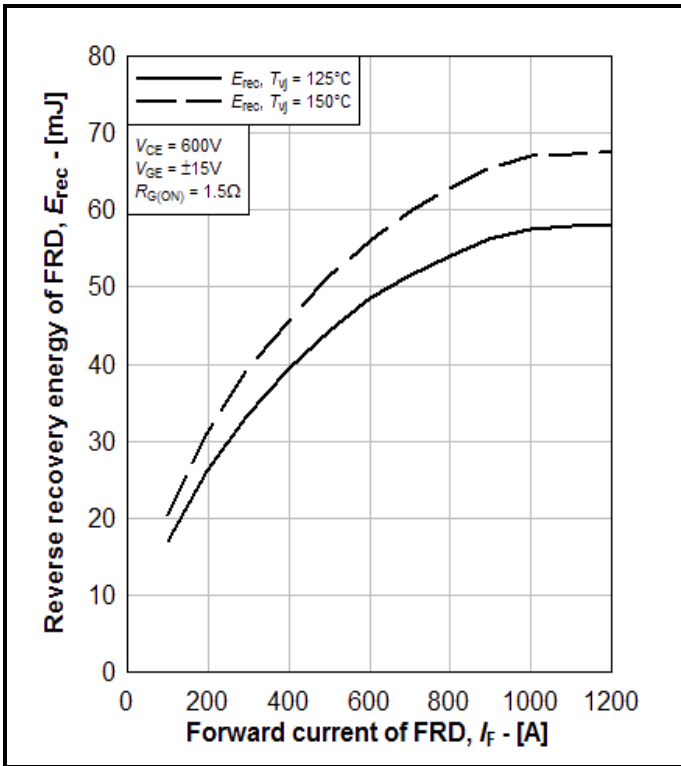

Fig. 9 Typical FRD E_{rec} , $E_{rec} = f(I_F)$

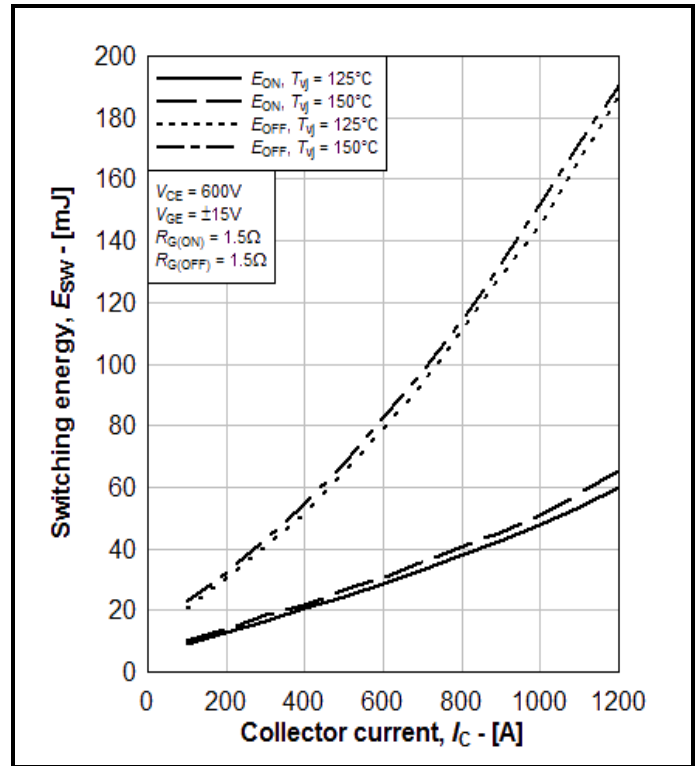

Fig. 10 Typical IGBT switching energy, $E_{ON} = f(I_C)$, $E_{OFF} = f(I_C)$

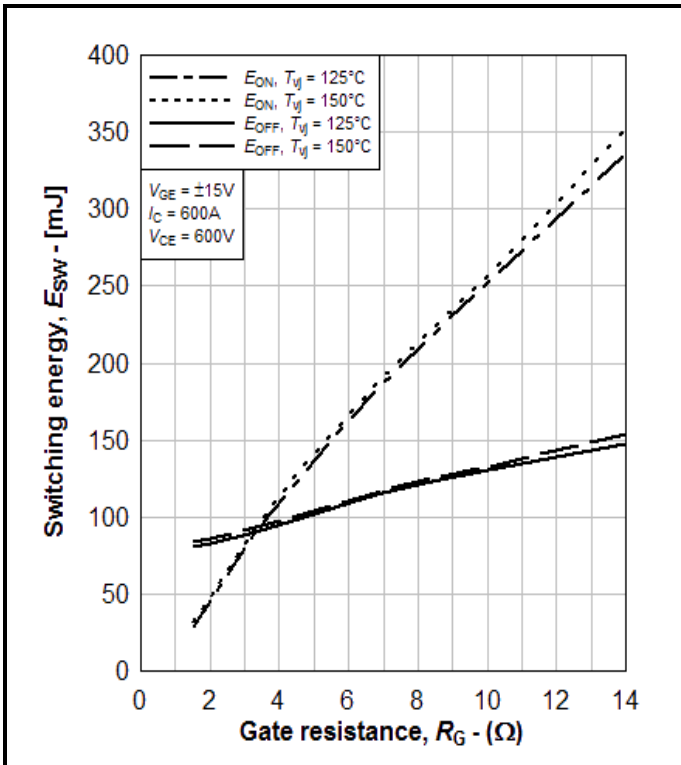

Fig. 11 Typical IGBT switching energy
 $E_{ON} = f(R_G)$, $E_{OFF} = f(R_G)$

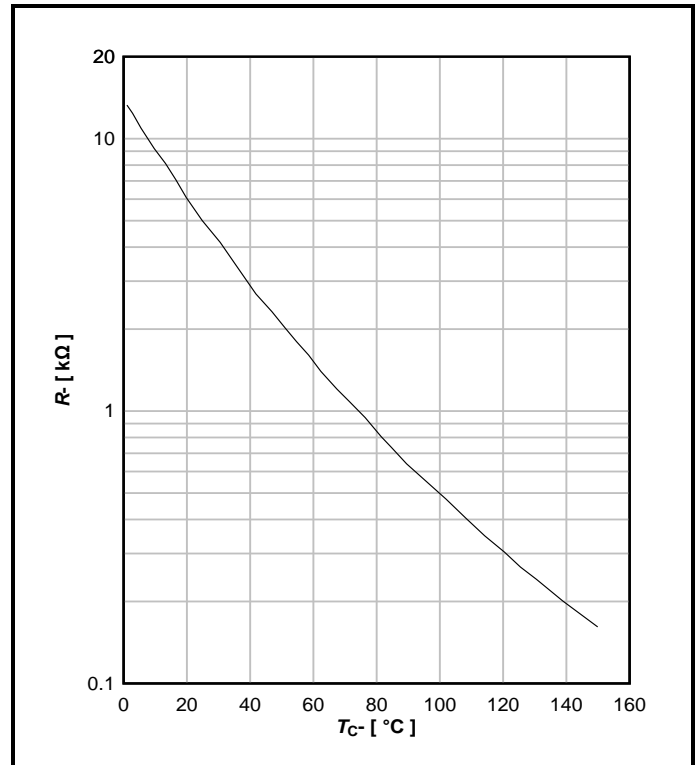

Fig. 12 Typical NTC thermistor characteristic, $R = f(T_C)$

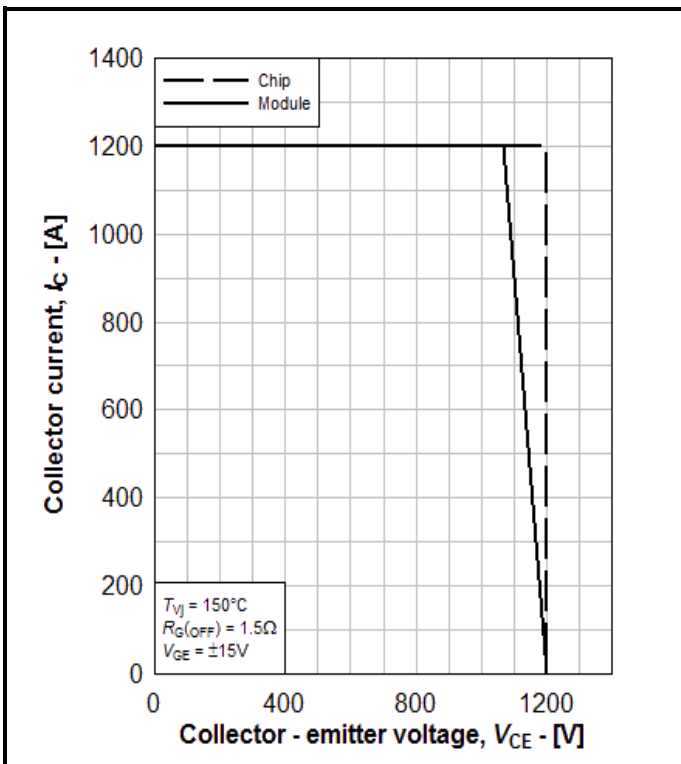

Fig. 13 Reverse bias safe operating area of IGBT,
 $I_C = f(V_{CE})$

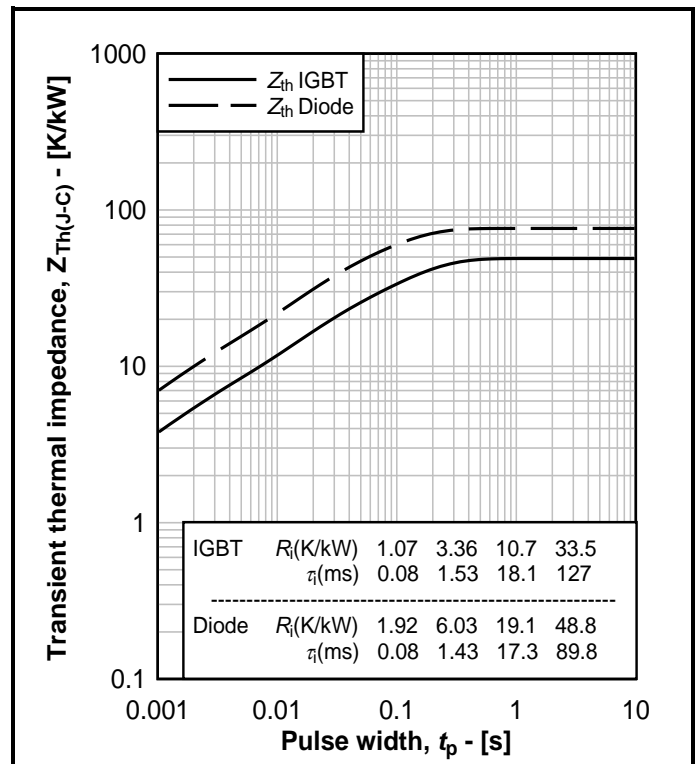
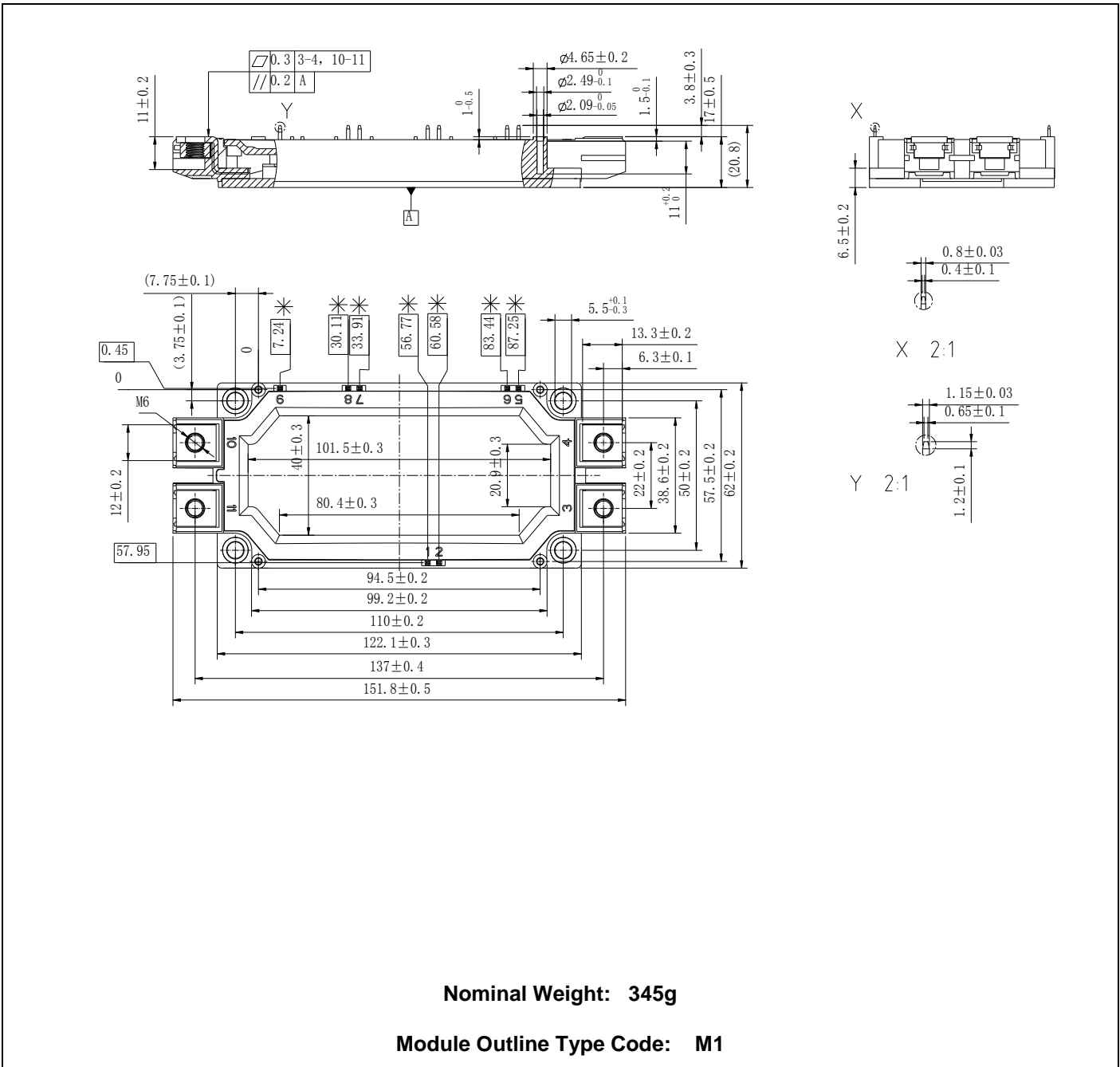

Fig. 14 Transient thermal impedance, $Z_{th(J-C)} = f(t)$

PACKAGE DETAILS

For further package information, please visit our website or contact Customer Services.
 All dimensions in mm, unless stated otherwise.
DO NOT SCALE.



IMPORTANT INFORMATION:

This publication is provided for information only and not for resale.

The products and information in this publication are intended for use by appropriately trained technical personnel.

Due to the diversity of product applications, the information contained herein is provided as a general guide only and does not constitute any guarantee of suitability for use in a specific application. The user must evaluate the suitability of the product and the completeness of the product data for the application. The user is responsible for product selection and ensuring all safety and any warning requirements are met. Should additional product information be needed please contact Customer Service.

Although we have endeavoured to carefully compile the information in this publication it may contain inaccuracies or typographical errors. The information is provided without any warranty or guarantee of any kind.

This publication is an uncontrolled document and is subject to change without notice. When referring to it please ensure that it is the most up to date version and has not been superseded.

The products are not intended for use in applications where a failure or malfunction may cause loss of life, injury or damage to property. The user must ensure that appropriate safety precautions are taken to prevent or mitigate the consequences of a product failure or malfunction.

The products must not be touched when operating because there is a danger of electrocution or severe burning. Always use protective safety equipment such as appropriate shields for the product and wear safety glasses. Even when disconnected any electric charge remaining in the product must be discharged and allowed to cool before safe handling using protective gloves.

Extended exposure to conditions outside the product ratings may affect reliability leading to premature product failure. Use outside the product ratings is likely to cause permanent damage to the product. In extreme conditions, as with all semiconductors, this may include potentially hazardous rupture, a large current to flow or high voltage arcing, resulting in fire or explosion. Appropriate application design and safety precautions should always be followed to protect persons and property.

Product Status & Product Ordering:

We annotate datasheets in the top right hand corner of the front page, to indicate product status if it is not yet fully approved for production. The annotations are as follows:-

Target Information:	This is the most tentative form of information and represents a very preliminary specification. No actual design work on the product has been started.
Preliminary Information:	The product design is complete and final characterisation for volume production is in progress. The datasheet represents the product as it is now understood but details may change.
No Annotation:	The product has been approved for production and unless otherwise notified by Dynex any product ordered will be supplied to the current version of the data sheet prevailing at the time of our order acknowledgement.

All products and materials are sold and services provided subject to Dynex's conditions of sale, which are available on request.

Any brand names and product names used in this publication are trademarks, registered trademarks or trade names of their respective owners.

HEADQUARTERS OPERATIONS**DYNEX SEMICONDUCTOR LTD**

Doddington Road, Lincoln, Lincolnshire, LN6 3LF,
United Kingdom

Tel: +44(0)1522 500500

Web: <http://www.dynexsemi.com>

CUSTOMER SERVICE**DYNEX SEMICONDUCTOR LTD**

Doddington Road, Lincoln, Lincolnshire, LN6 3LF,
United Kingdom

Tel: +44(0)1522 502753 / 502901

Email: Powersolutions@dynexsemi.com