

FEATURES

- Double Side Cooling
- High Reliability In Service
- High Voltage Capability
- Fault Protection Without Fuses
- High Surge Current Capability
- Turn-off Capability Allows Reduction In Equipment Size And Weight. Low Noise Emission Reduces Acoustic Cladding Necessary For Environmental Requirements

APPLICATIONS

- Variable speed A.C. motor drive inverters (VSD-AC)
- Uninterruptable Power Supplies
- High Voltage Converters
- Choppers
- Welding
- Induction Heating
- DC/DC Converters

KEY PARAMETERS

I_{TCM}	700A
V_{DRM}	1800V
$I_{T(AV)}$	240A
dV_D/dt	500V/μs
di_T/dt	500A/μs

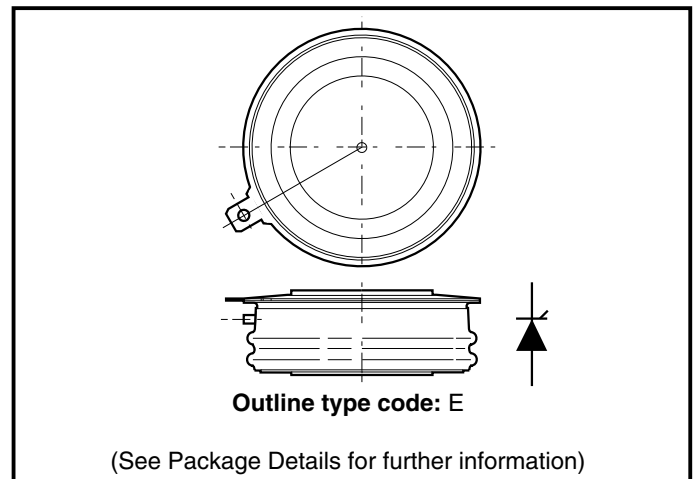

Fig. 1 Package outline

VOLTAGE RATINGS

Type Number	Repetitive Peak Off-state Voltage V_{DRM} V	Repetitive Peak Reverse Voltage V_{RRM} V	Conditions
DGT305SE18	1800	16	$T_{vj} = 125^{\circ}\text{C}$, $I_{DM} = 50\text{mA}$, $I_{RRM} = 50\text{mA}$, $V_{RG} = 2\text{V}$

CURRENT RATINGS

Symbol	Parameter	Conditions	Max.	Units
I_{TCM}	Repetitive peak controllable on-state current	$V_D = 67\%V_{DRM}$, $T_j = 125^{\circ}\text{C}$, $di_{GD}/dt = 15\text{A}/\mu\text{s}$, $C_s = 1.5\mu\text{F}$	700	A
$I_{T(AV)}$	Mean on-state current	$T_{HS} = 80^{\circ}\text{C}$. Double side cooled. Half sine 50Hz.	240	A
$I_{T(RMS)}$	RMS on-state current	$T_{HS} = 80^{\circ}\text{C}$. Double side cooled. Half sine 50Hz.	373	A

SURGE RATINGS

Symbol	Parameter	Conditions	Max.	Units
I_{TSM}	Surge (non-repetitive) on-state current	10ms half sine. $T_j = 125^\circ\text{C}$	4.0	kA
I^2t	I^2t for fusing	10ms half sine. $T_j = 125^\circ\text{C}$	80000	A^2s
di_T/dt	Critical rate of rise of on-state current	$V_D = 67\% V_{DRM}$, $I_T = 700\text{A}$, $T_j = 125^\circ\text{C}$, $I_{FG} > 20\text{A}$, Rise time $< 1.0\mu\text{s}$	500	$\text{A}/\mu\text{s}$
dV_D/dt	Rate of rise of off-state voltage	To 80% V_{DRM} ; $R_{GK} \leq 1.5\Omega$, $T_j = 125^\circ\text{C}$	500	$\text{V}/\mu\text{s}$
V_{DP}	Peak forward transient voltage during current fall time	$V_D = 67\% V_{DRM}$, $I_T = 700\text{A}$, $T_j = 125^\circ\text{C}$, $di_{GQ}/dt = 15\text{A}/\mu\text{s}$, $C_s = 1.5\mu\text{F}$	400	V

GATE RATINGS

Symbol	Parameter	Conditions	Min.	Max.	Units
V_{RGM}	Peak reverse gate voltage	This value maybe exceeded during turn-off	-	16	V
I_{FGM}	Peak forward gate current		-	50	A
$P_{FG(AV)}$	Average forward gate power		-	10	W
P_{RGM}	Peak reverse gate power		-	6	kW
di_{GQ}/dt	Rate of rise of reverse gate current		10	50	$\text{A}/\mu\text{s}$
$t_{ON(min)}$	Minimum permissible on time		20	-	μs
$t_{OFF(min)}$	Minimum permissible off time		40	-	μs

THERMAL RATINGS

Symbol	Parameter	Conditions	Min.	Max.	Units	
$R_{th(j-hs)}$	DC thermal resistance - junction to heatsink surface	Double side cooled	-	0.075	$^\circ\text{C}/\text{W}$	
		Anode side cooled	-	0.12	$^\circ\text{C}/\text{W}$	
		Cathode side cooled	-	0.20	$^\circ\text{C}/\text{W}$	
$R_{th(c-hs)}$	Contact thermal resistance	Clamping force 5.5kN With mounting compound	per contact	-	0.018	$^\circ\text{C}/\text{W}$
T_{vj}	Virtual junction temperature		-	125	$^\circ\text{C}$	
T_{OP}/T_{stg}	Operating junction/storage temperature range		-40	125	$^\circ\text{C}$	
-	Clamping force		5.0	6.0	kN	

CHARACTERISTICS

T_j = 125°C unless stated otherwise					
Symbol	Parameter	Conditions	Min.	Max.	Units
V _{TM}	On-state voltage	At 600A peak, I _{G(ON)} = 2A d.c.	-	2.5	V
I _{DM}	Peak off-state current	At V _{DRM} , V _{RG} = 2V	-	50	mA
I _{RRM}	Peak reverse current	At V _{RRM}	-	50	mA
V _{GT}	Gate trigger voltage	V _D = 24V, I _T = 100A, T _j = 25°C	-	0.75	V
I _{GT}	Gate trigger current	V _D = 24V, I _T = 100A, T _j = 25°C	-	1.2	A
I _{RGM}	Reverse gate cathode current	V _{RGM} = 16V, No gate/cathode resistor	-	50	mA
E _{ON}	Turn-on energy	V _D = 1200V, I _T = 600A,	-	160	mJ
t _d	Delay time	I _{FG} = 20A, rise time < 1.0μs	-	1.1	μs
t _r	Rise time	R _L = (Residual inductance 2.75μH)	-	2.5	μs
E _{OFF}	Turn-off energy	I _T = 600A, V _D = 1200V, Snubber Cap Cs = 1.5μF, di _{GQ} /dt = 15A/μs R _L = (Residual inductance 2.75μH)	-	550	mJ
t _{tail}	Tail time		-	30	μs
t _{gs}	Storage time		-	12	μs
t _{gf}	Fall time		-	1.5	μs
t _{gq}	Gate controlled turn-off time		-	13.5	μs
Q _{GQ}	Turn-off gate charge		-	900	μC
Q _{GQT}	Total turn-off gate charge		-	1800	μC

CURVES

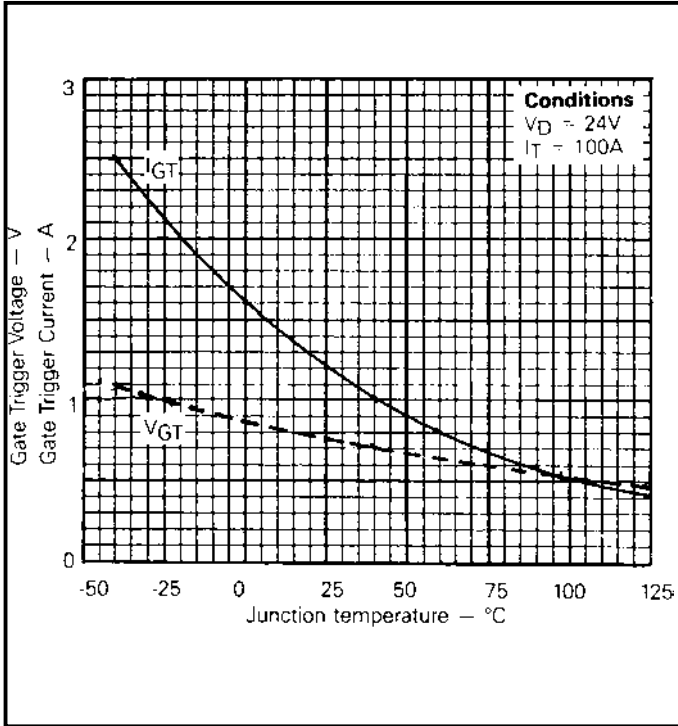

Fig.2 Gate characteristics

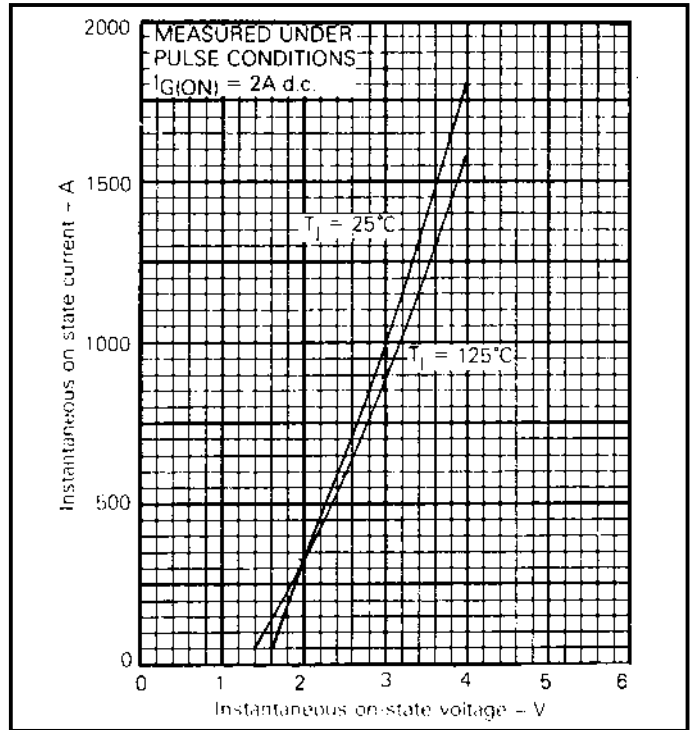

Fig.3 Maximum (limit) on-state characteristics

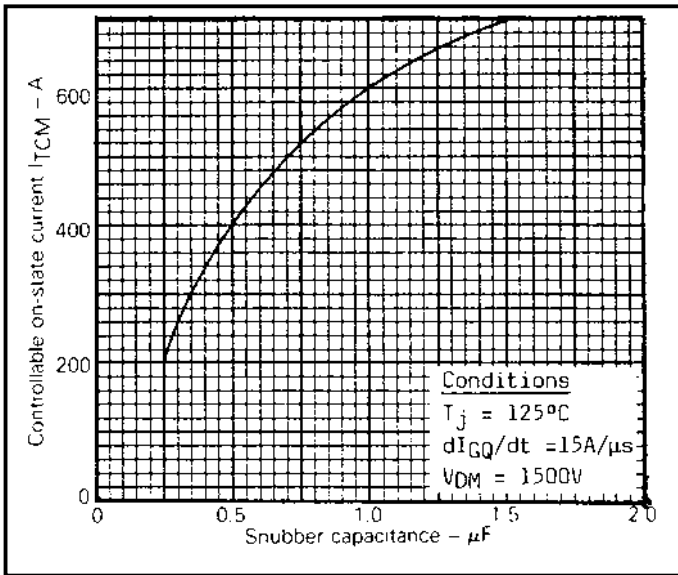

Fig.4 Dependence of I_{TCM} on C_s

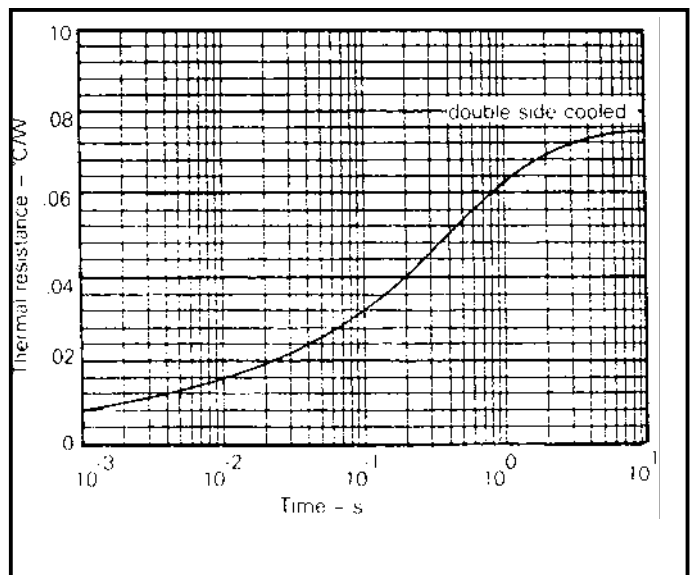

Fig.5 Maximum (limit) transient thermal resistance

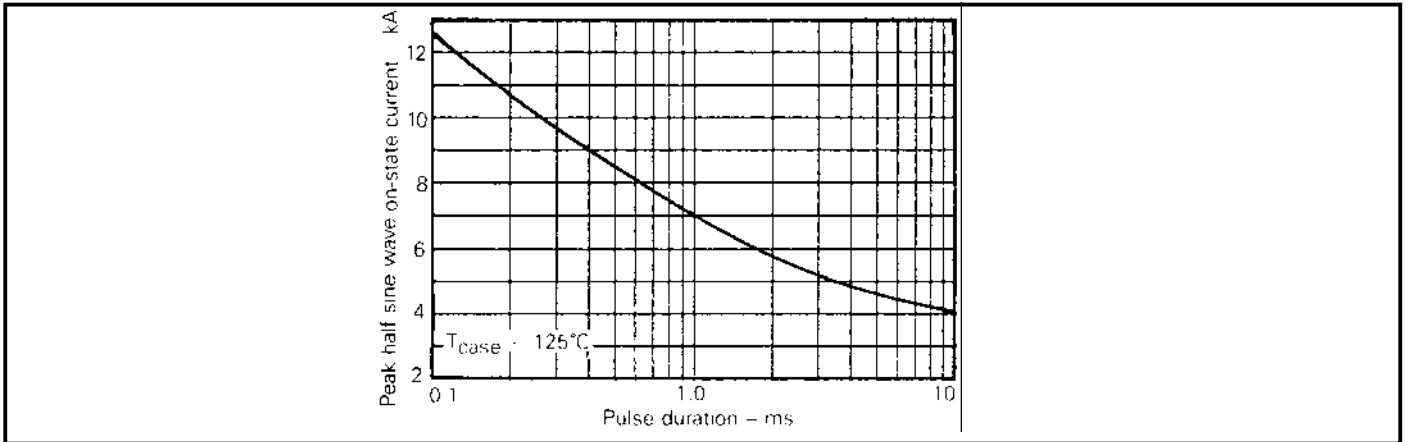

Fig.6 Surge (non-repetitive) on-state current vs time

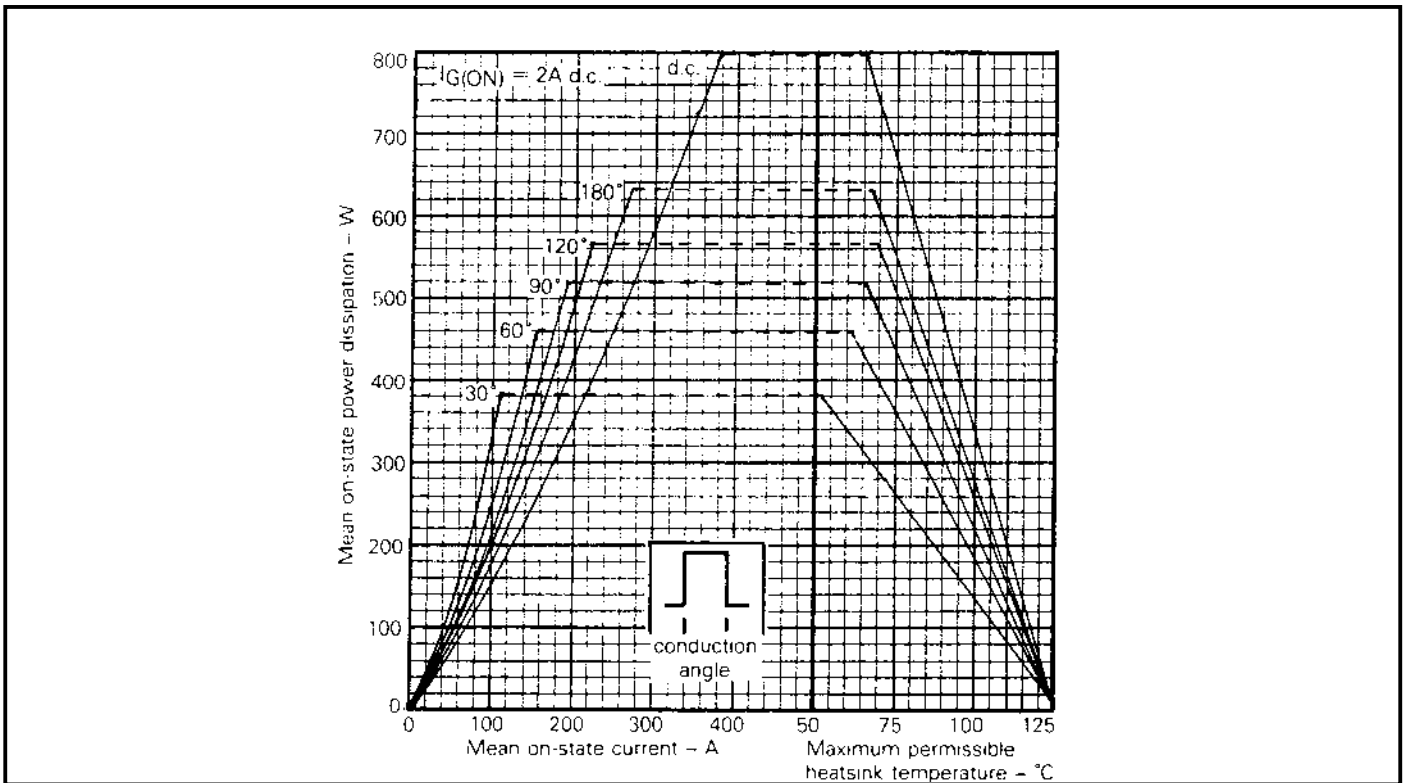

Fig.7 Steady state rectangular wave conduction loss - double side cooled

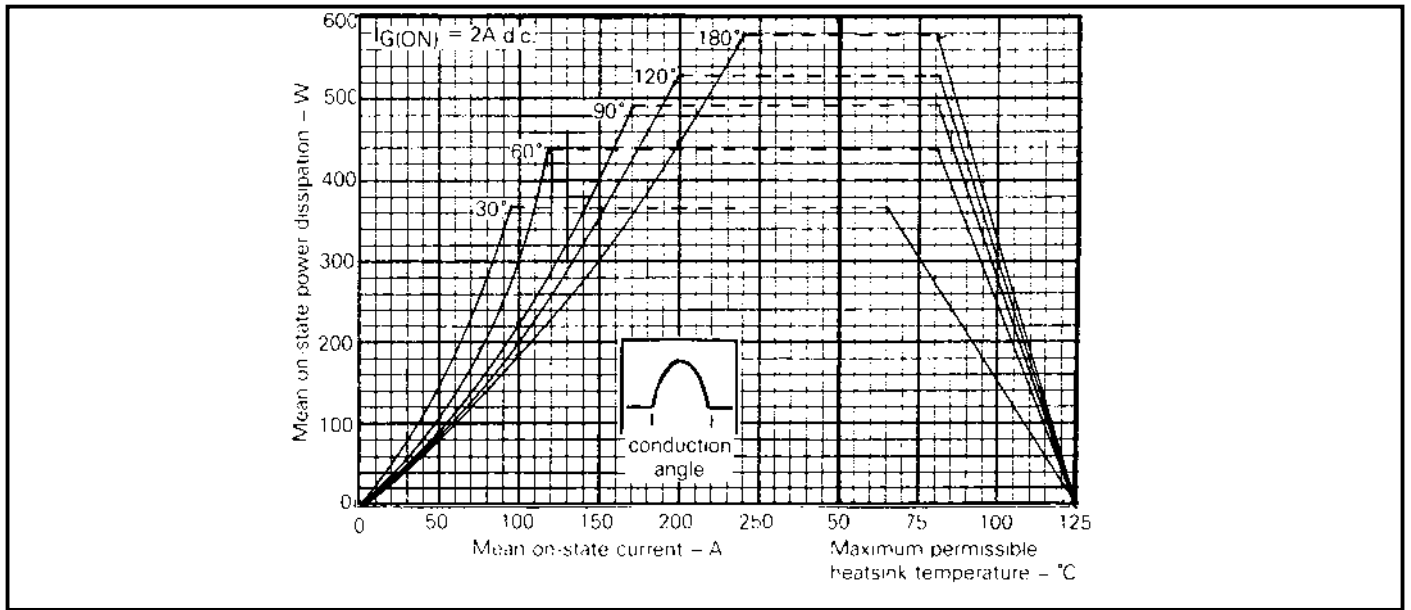

Fig.8 Steady state sinusoidal wave conduction loss - double side cooled

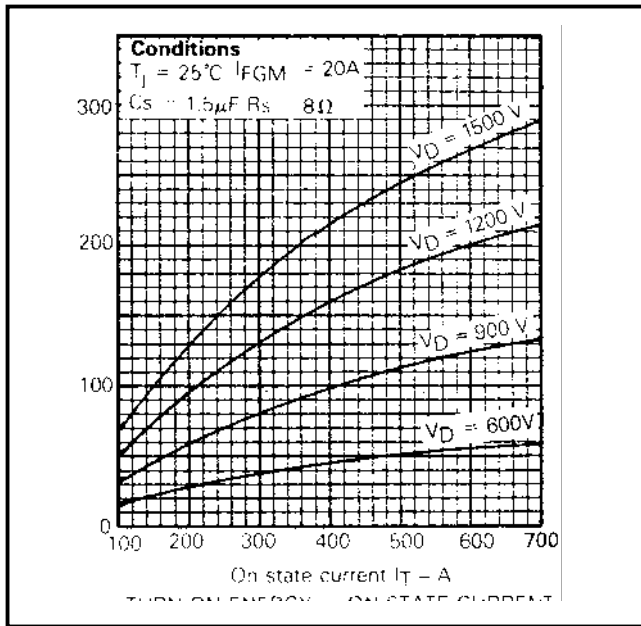

Fig.9 Turn-on energy vs on-state current

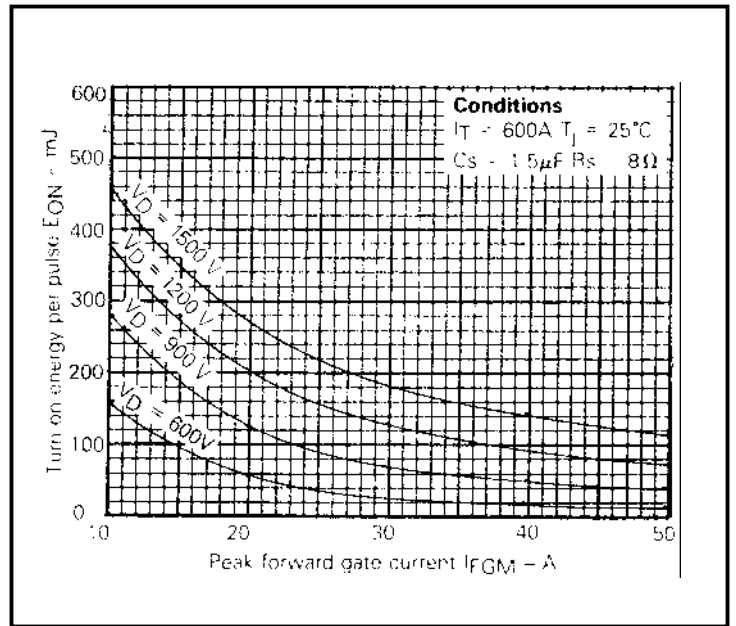

Fig.10 Turn-on energy vs peak forward gate current

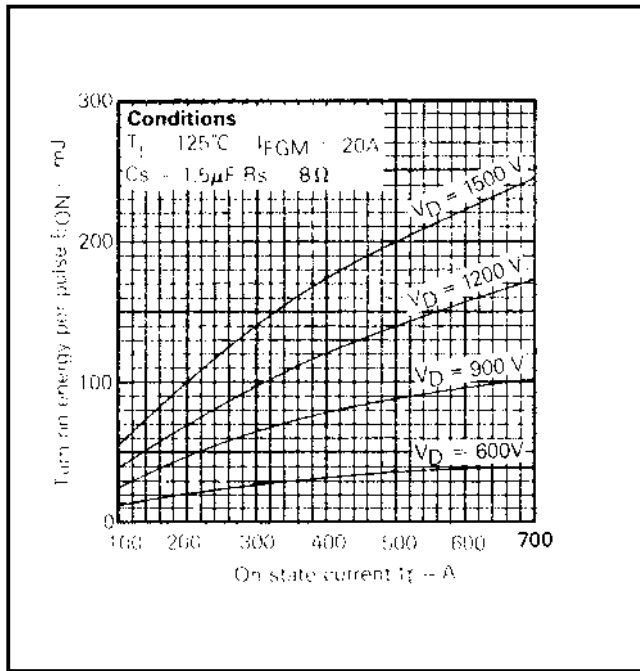

Fig.11 Turn-on energy vs on-state current

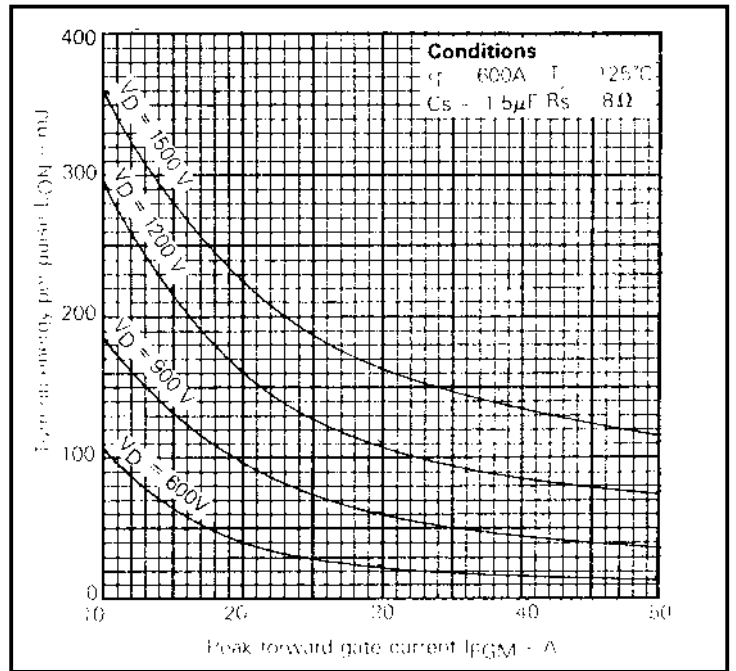

Fig.12 Turn-on energy vs peak forward gate current

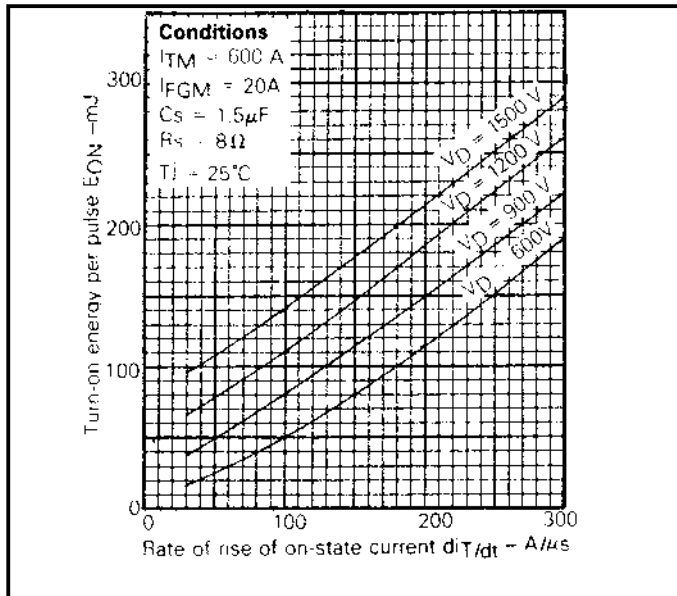

Fig.13 Turn-on energy vs rate of rise of on-state current

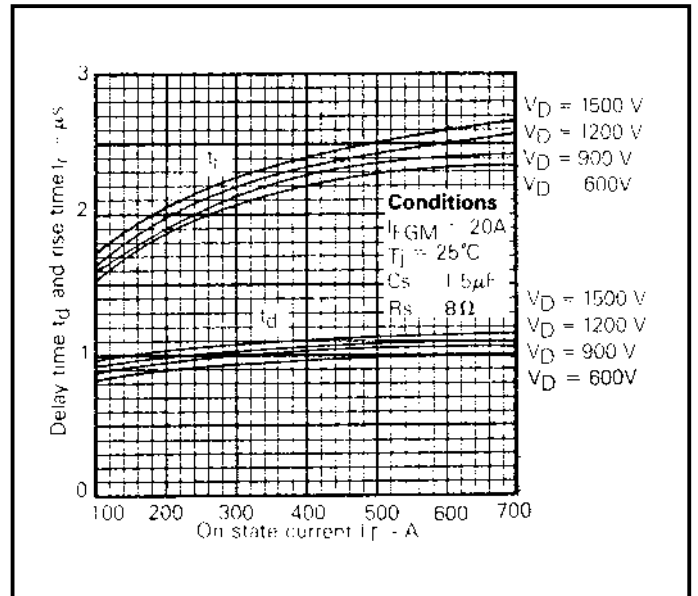

Fig.14 Delay time and rise time vs on-state current

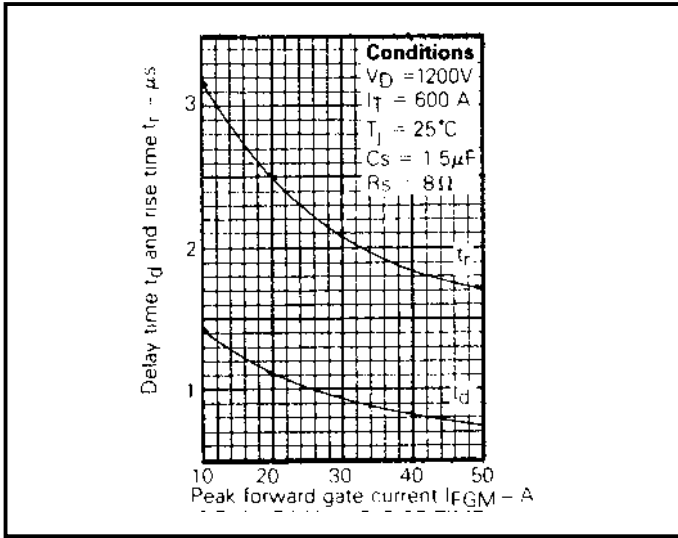

Fig.15 Delay time and rise time vs peak forward gate current

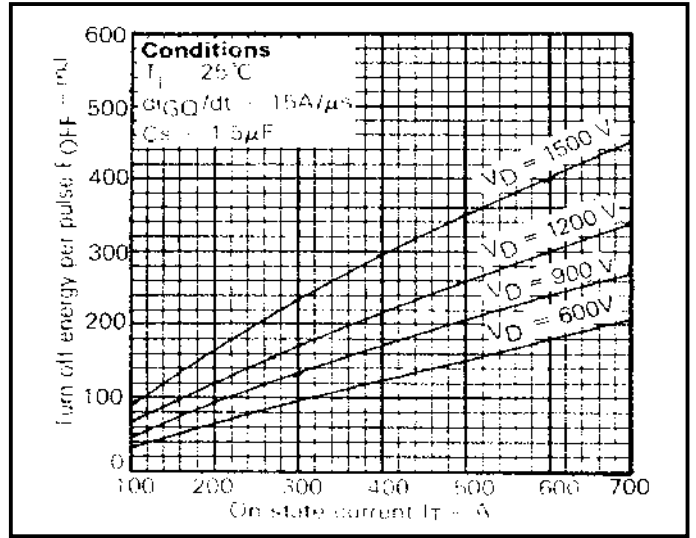

Fig.16 Turn-off energy vs on-state current

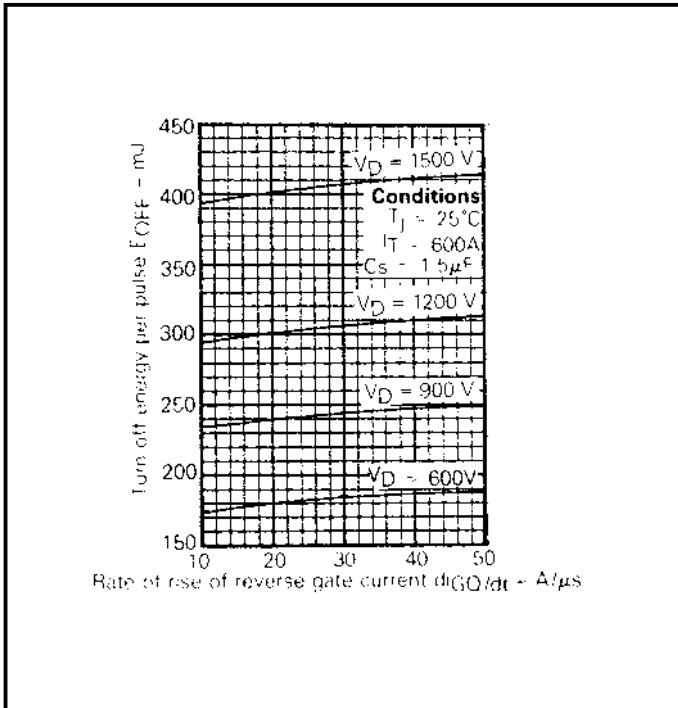

Fig.17 Turn-off energy vs rate of rise of reverse gate current

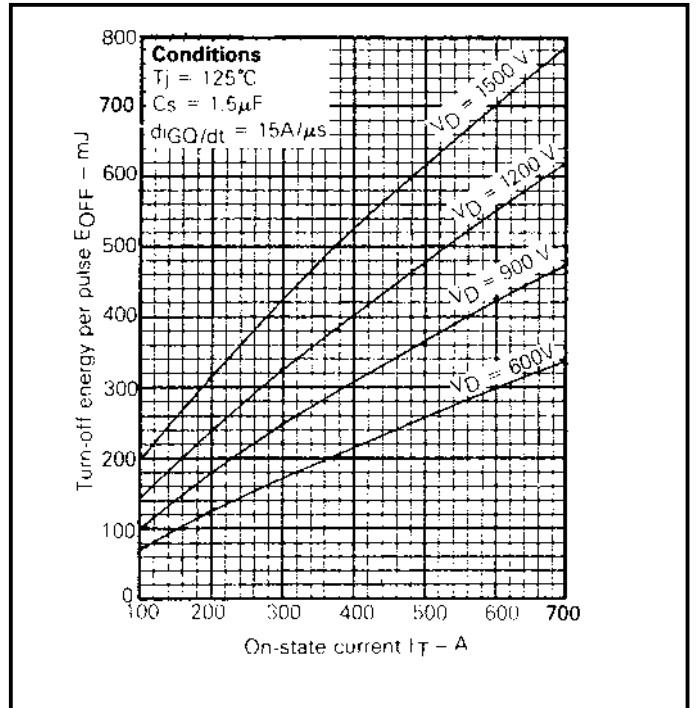

Fig.18 Turn-off energy vs on-state current

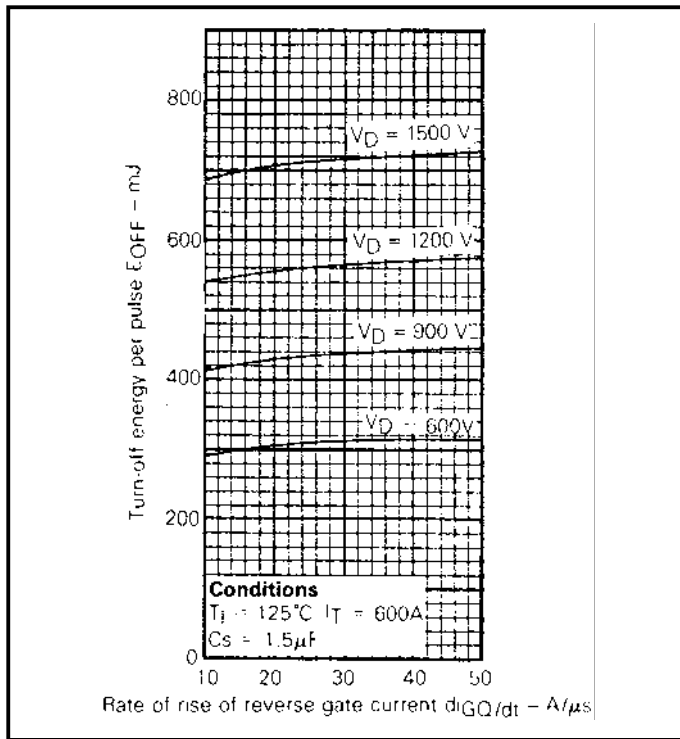

Fig.19 Turn-off energy vs rate of rise of reverse gate current

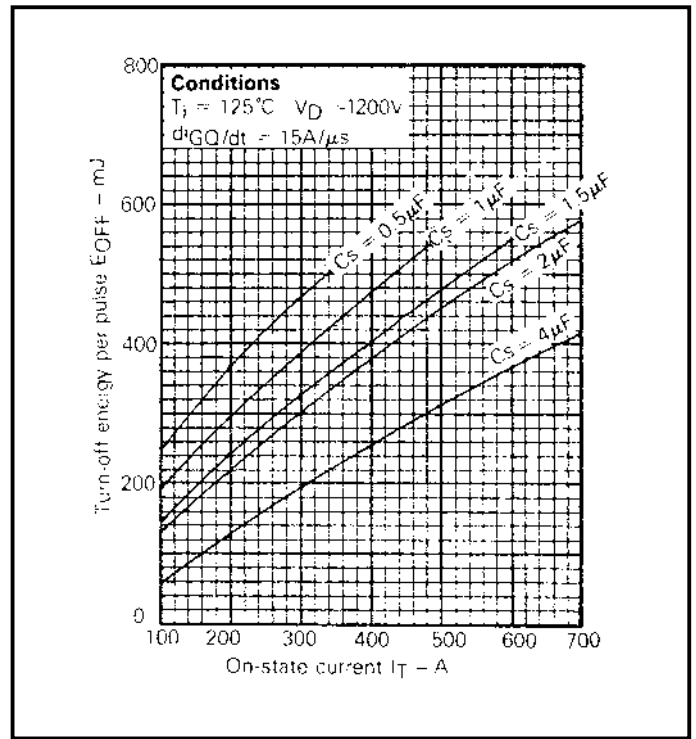

Fig.20 Turn-off energy vs on-state current with C_s as parameter

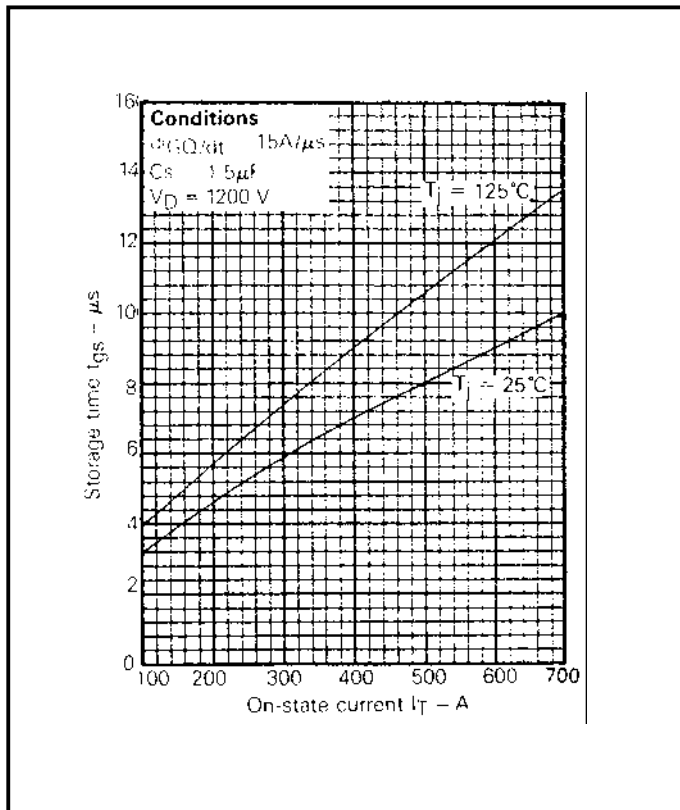

Fig.21 Storage time vs on-state current

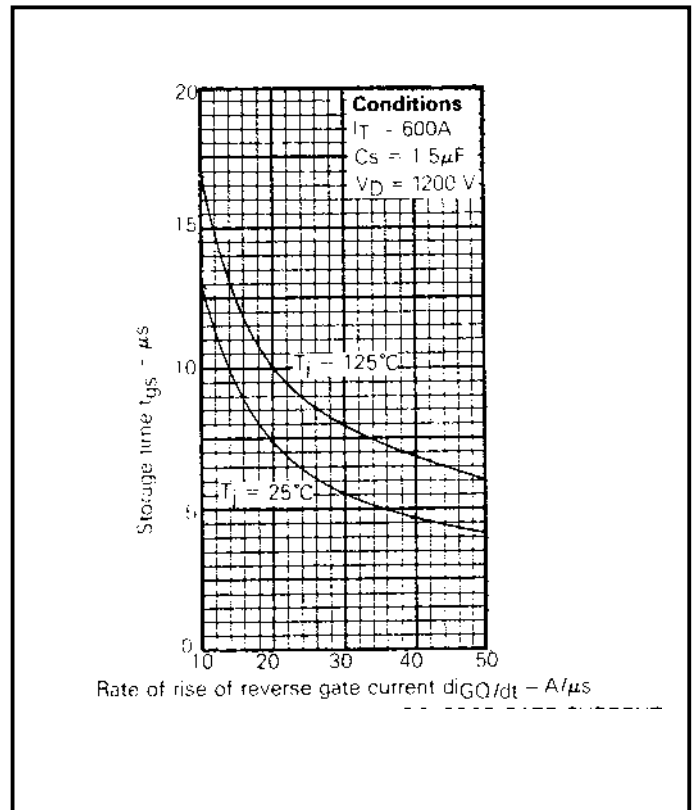

Fig.22 Storage time vs rate of rise of reverse gate current

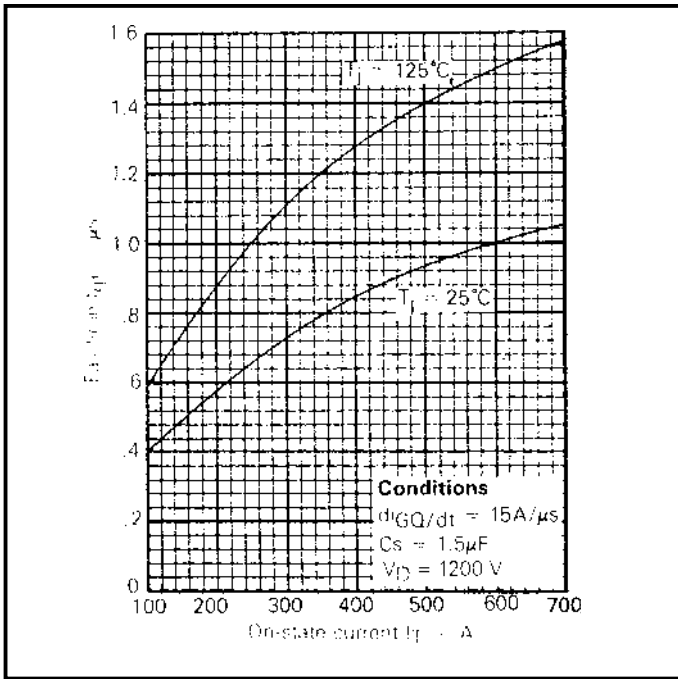

Fig.23 Fall time vs on-state current

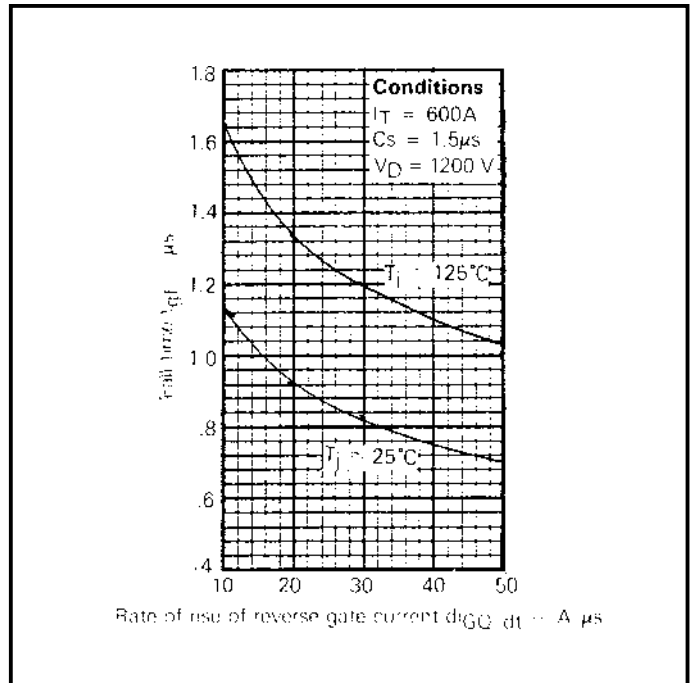

Fig.24 Fall time vs rate of rise of reverse gate current

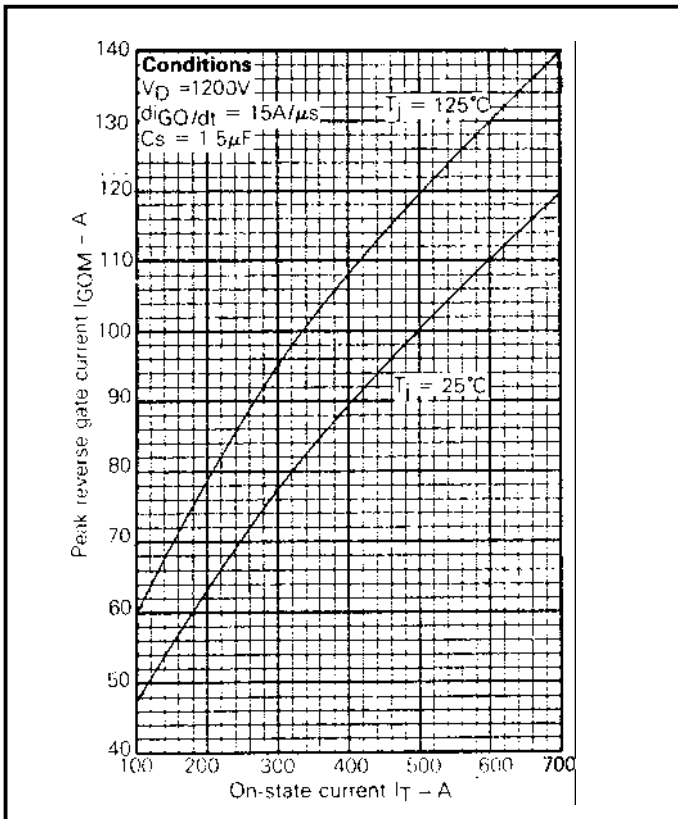

Fig.25 Peak reverse gate current vs on-state current

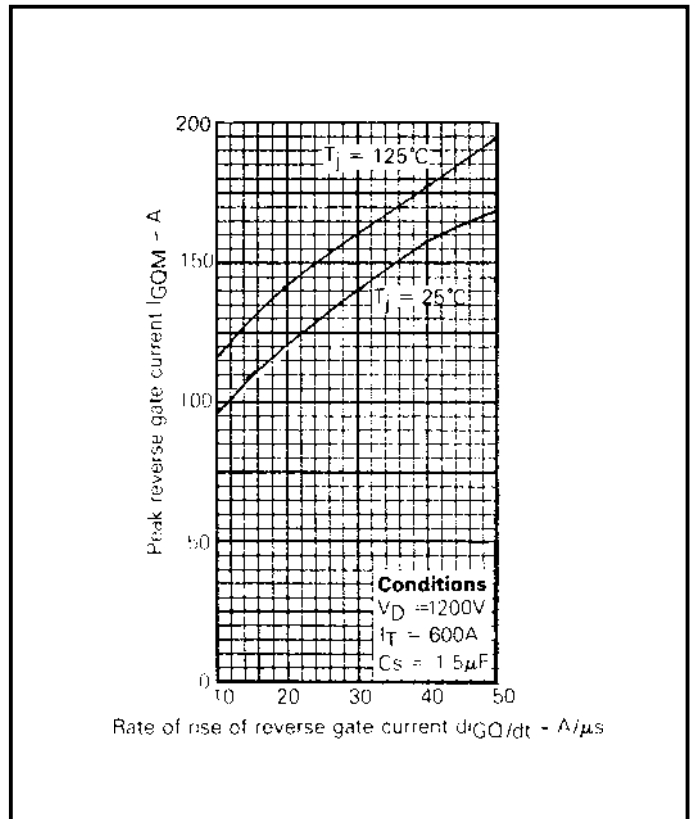

Fig.26 Peak reverse gate current vs rate of rise of reverse gate current

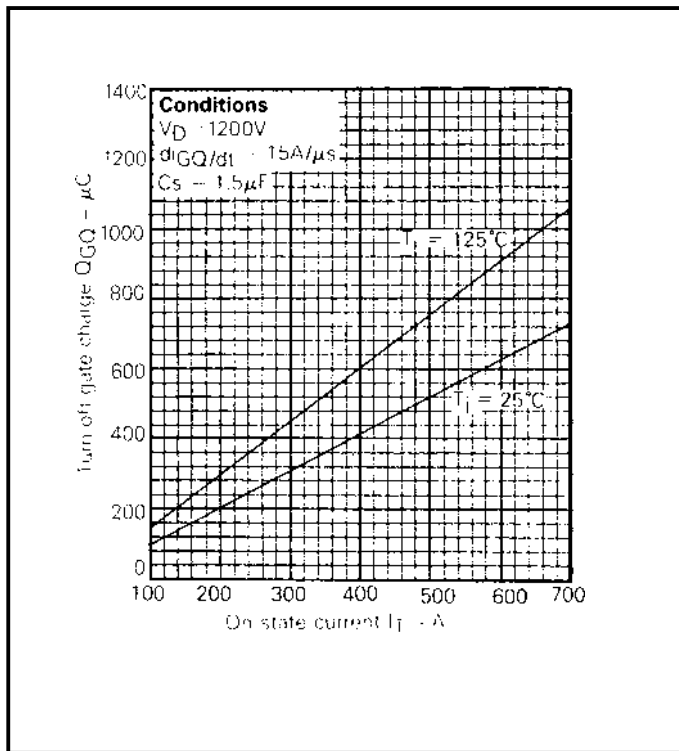

Fig.27 Turn-off gate charge vs on-state current

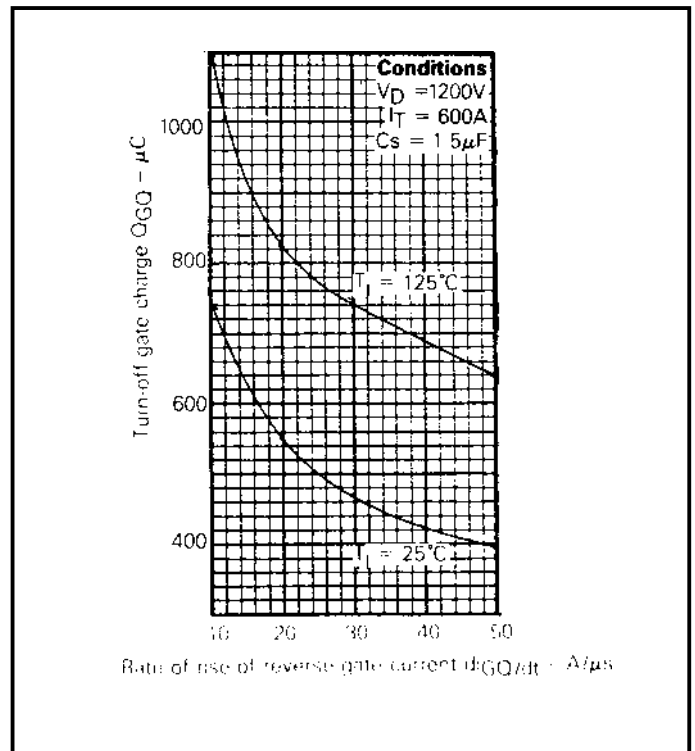

Fig.28 Turn-off gate charge vs rate of rise of reverse gate current

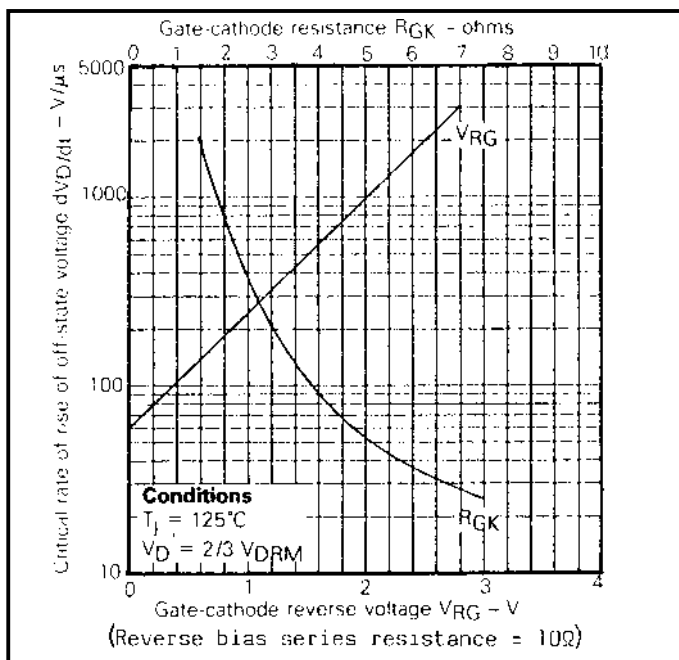
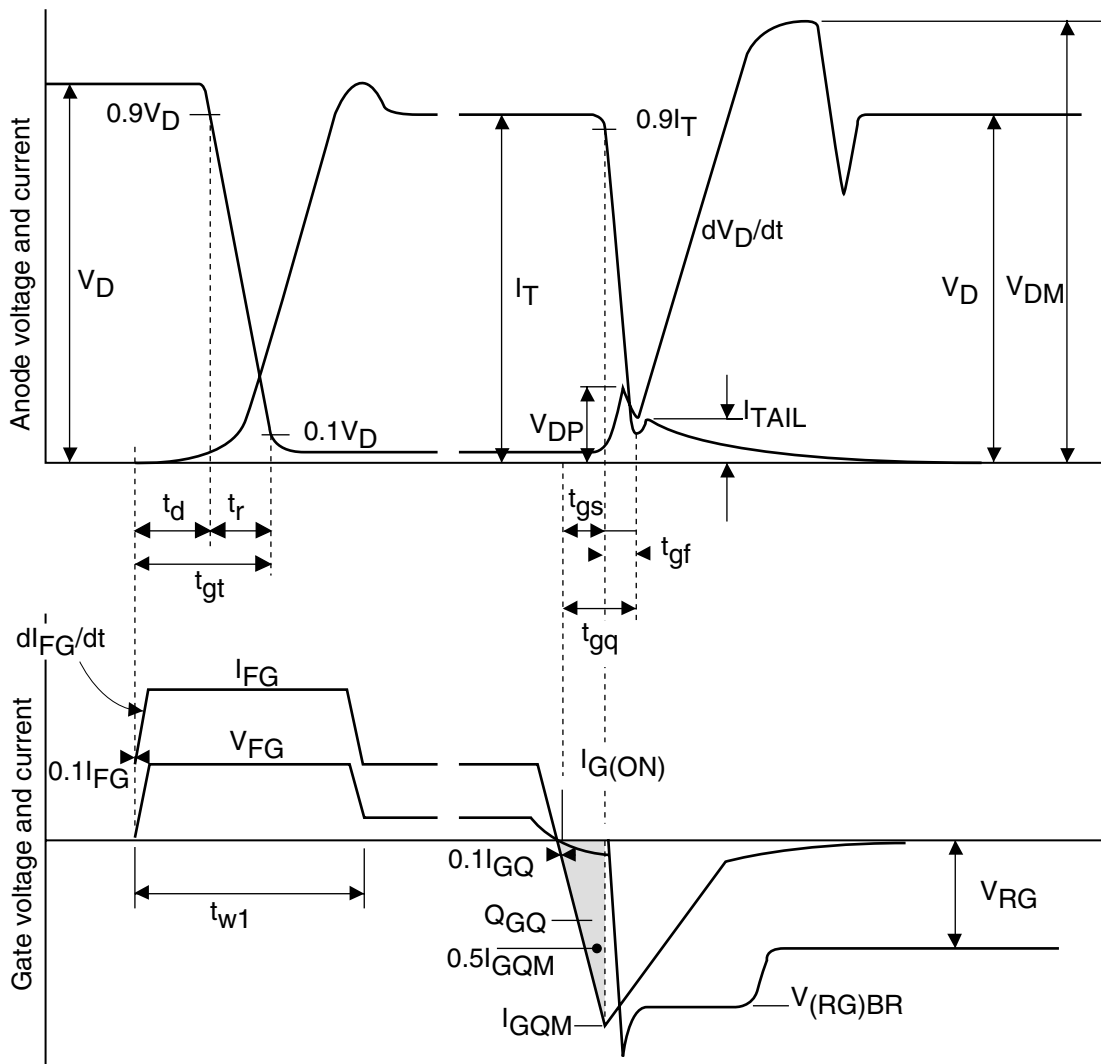

Fig.29 Dependence of critical dv_D/dt on gate-cathode resistance and gate-cathode reverse voltage

Snubber Capacitor C_s (μF)	Snubber Resistor R_s (Ω)	Minimum Reset Time (μs)
2	7	35
	5	30
15	7	26
	5	22
1	7	17
	5	15

Table of snubber discharge time variation with snubber capacitor value.



Recommended gate conditions:

- $I_{TCM} = 600A$
- $I_{FG} = 20A$
- $I_{G(ON)} = 2A \text{ d.c.}$
- $t_{w1(\text{min})} = 4.5\mu s$
- $I_{GQM} = 130A$
- $di_{GQ}/dt = 15A/\mu s$
- $Q_{GQ} = 900\mu C$
- $V_{RG(\text{min})} = 2V$
- $V_{RG(\text{max})} = 16V$

These are recommended Dynex Semiconductor conditions. Other conditions are permitted according to users gate drive specifications.

Fig.30 General switching waveforms

PACKAGE DETAILS

For further package information, please contact Customer Services. All dimensions in mm, unless stated otherwise. DO NOT SCALE.

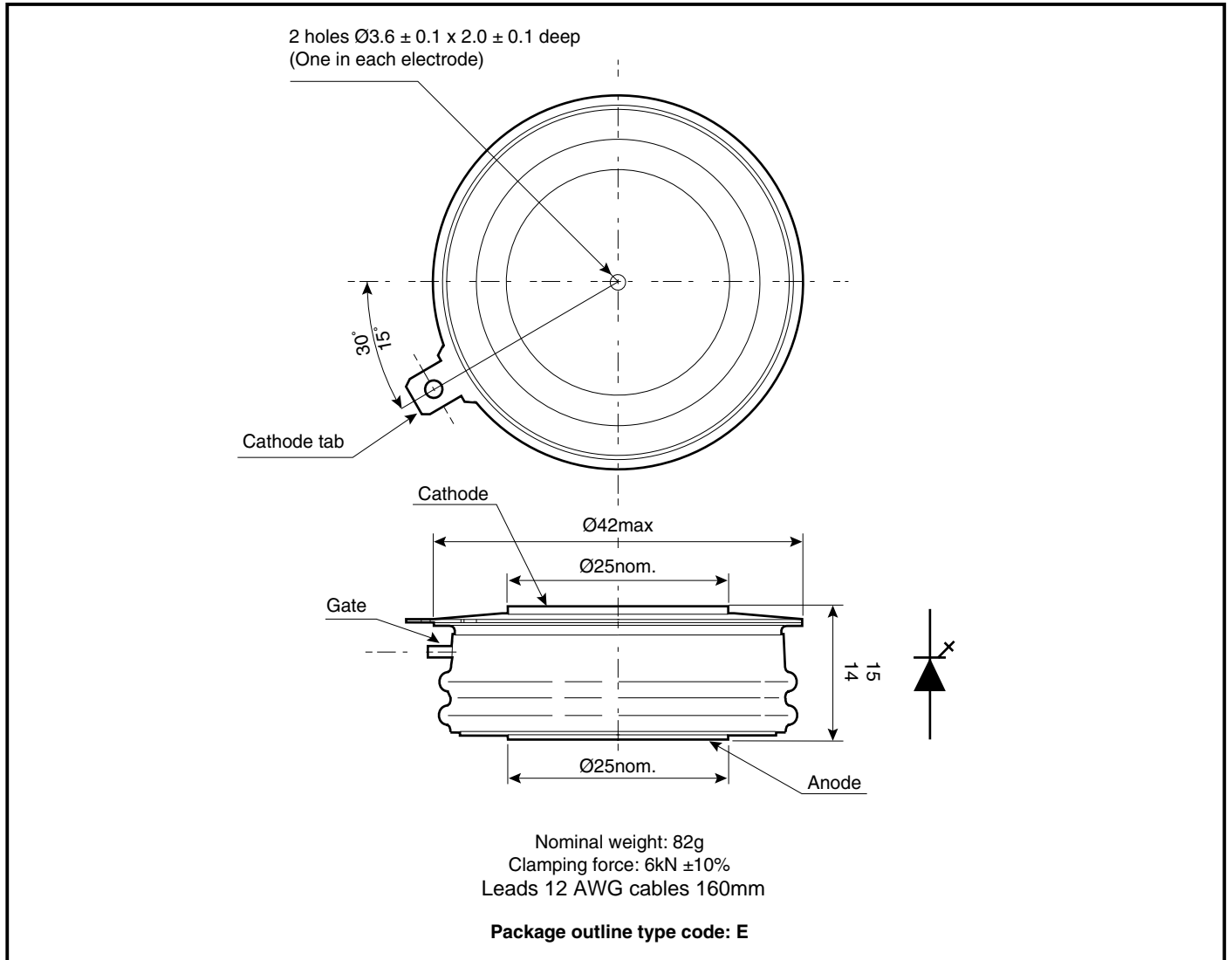



IMPORTANT INFORMATION:

This publication is provided for information only and not for resale.

The products and information in this publication are intended for use by appropriately trained technical personnel.

Due to the diversity of product applications, the information contained herein is provided as a general guide only and does not constitute any guarantee of suitability for use in a specific application. The user must evaluate the suitability of the product and the completeness of the product data for the application. The user is responsible for product selection and ensuring all safety and any warning requirements are met. Should additional product information be needed please contact Customer Service.

Although we have endeavoured to carefully compile the information in this publication it may contain inaccuracies or typographical errors. The information is provided without any warranty or guarantee of any kind.

This publication is an uncontrolled document and is subject to change without notice. When referring to it please ensure that it is the most up to date version and has not been superseded.

The products are not intended for use in applications where a failure or malfunction may cause loss of life, injury or damage to property. The user must ensure that appropriate safety precautions are taken to prevent or mitigate the consequences of a product failure or malfunction.

The products must not be touched when operating because there is a danger of electrocution or severe burning. Always use protective safety equipment such as appropriate shields for the product and wear safety glasses. Even when disconnected any electric charge remaining in the product must be discharged and allowed to cool before safe handling using protective gloves.

Extended exposure to conditions outside the product ratings may affect reliability leading to premature product failure. Use outside the product ratings is likely to cause permanent damage to the product. In extreme conditions, as with all semiconductors, this may include potentially hazardous rupture, a large current to flow or high voltage arcing, resulting in fire or explosion. Appropriate application design and safety precautions should always be followed to protect persons and property.

Product Status & Product Ordering:

We annotate datasheets in the top right hand corner of the front page, to indicate product status if it is not yet fully approved for production. The annotations are as follows:-

Target Information:	This is the most tentative form of information and represents a very preliminary specification. No actual design work on the product has been started.
Preliminary Information:	The product design is complete and final characterisation for volume production is in progress. The datasheet represents the product as it is now understood but details may change.
No Annotation:	The product has been approved for production and unless otherwise notified by Dynex any product ordered will be supplied to the current version of the data sheet prevailing at the time of our order acknowledgement.

All products and materials are sold and services provided subject to Dynex's conditions of sale, which are available on request.

Any brand names and product names used in this publication are trademarks, registered trademarks or trade names of their respective owners.

HEADQUARTERS OPERATIONS

DYNEX SEMICONDUCTOR LIMITED
Doddington Road, Lincoln, Lincolnshire, LN6 3LF
United Kingdom.
Phone: +44 (0) 1522 500500
Fax: +44 (0) 1522 500550
Web: <http://www.dynexsemi.com>

CUSTOMER SERVICE

Phone: +44 (0) 1522 502753 / 502901
Fax: +44 (0) 1522 500020
e-mail: power_solutions@dynexsemi.com