

FEATURES

- Double Side Cooling
- High Reliability In Service
- High Voltage Capability
- Fault Protection Without Fuses
- High Surge Current Capability
- Turn-off Capability Allows Reduction in Equipment Size and Weight. Low Noise Emission Reduces Acoustic Cladding Necessary For Environmental Requirements

APPLICATIONS

- Variable speed AC motor drive inverters (VSD-AC)
- Uninterruptable Power Supplies
- High Voltage Converters
- Choppers
- Welding
- Induction Heating
- DC/DC Converters

KEY PARAMETERS

V_{DRM}	2500V
$I_{T(AV)}$	225A
I_{TCM}	600A
dV_D/dt	1000V/μs
dl_T/dt	300A/μs

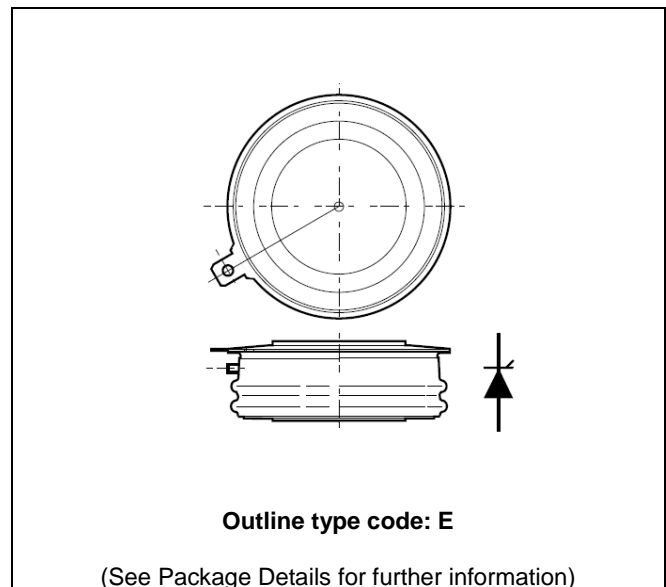
Fig. 1 Package outline
VOLTAGE RATINGS

Type Number	Repetitive Peak Off-state Voltage V_{DRM} (V)	Repetitive Peak Reverse Voltage V_{RRM} (V)	Conditions
DG306AE25	2500	16	$T_{vj} = 125^{\circ}\text{C}$, $I_{DM} = 50\text{mA}$, $I_{RRM} = 50\text{mA}$, $V_{RG} = 2\text{V}$

CURRENT RATINGS

Symbol	Parameter	Conditions	Max.	Units
I_{TCM}	Repetitive peak controllable on-state current	$V_D = 67\%V_{DRM}$, $T_j = 125^{\circ}\text{C}$, $dl_{GQ}/dt = 15\text{A}/\mu\text{s}$, $C_S = 1.0 \mu\text{F}$	600	A
$I_{T(AV)}$	Mean on-state current	$T_{HS} = 80^{\circ}\text{C}$, Double side cooled. Half sine 50Hz	225	A
$I_{T(RMS)}$	RMS on-state current	$T_{HS} = 80^{\circ}\text{C}$, Double side cooled. Half sine 50Hz	350	A

SURGE RATINGS

Symbol	Parameter	Test Conditions	Max.	Units
I_{TSM}	Surge (non repetitive) on-state current	10ms half sine. $T_j = 125^\circ\text{C}$	3.5	kA
I^2t	I^2t for fusing	10ms half sine. $T_j = 125^\circ\text{C}$	61250	A^2s
di_T/dt	Critical rate of rise of on-state current	$V_D = 2000\text{V}$, $I_T = 600\text{A}$, $T_j = 125^\circ\text{C}$, $I_{FG} > 20\text{A}$, Rise time $> 1.0 \mu\text{s}$	300	$\text{A}/\mu\text{s}$
dV_D/dt	Rate of rise of off-state voltage	To 66% V_{DRM} ; $R_{GK} \leq 1.5\Omega$, $T_j = 125^\circ\text{C}$	500	$\text{V}/\mu\text{s}$
		To 66% V_{DRM} ; $V_{RG} \leq -2\text{V}$, $T_j = 125^\circ\text{C}$	1000	$\text{V}/\mu\text{s}$
L_S	Peak stray inductance in snubber circuit	-	200	nH

GATE RATINGS

Symbol	Parameter	Test Conditions	Min.	Max.	Units
V_{RGM}	Peak reverse gate voltage	This value may be exceeded during turn-off	-	16	V
I_{FGM}	Peak forward gate current		-	50	A
$P_{FG(AV)}$	Average forward gate power		-	10	W
P_{RGM}	Peak reverse gate power		-	6	kW
di_{GQ}/dt	Rate of rise of reverse gate current		10	50	$\text{A}/\mu\text{s}$
$t_{ON(min)}$	Minimum permissible on time		20	-	μs
$t_{OFF(min)}$	Minimum permissible off time		40	-	μs

THERMAL AND MECHANICAL RATINGS

Symbol	Parameter	Test Conditions	Min.	Max.	Units	
$R_{th(j-hs)}$	Thermal resistance – junction to heatsink surface	Double side cooled	DC	-	0.075	$^\circ\text{C}/\text{W}$
		Single side cooled	Anode DC	-	0.12	$^\circ\text{C}/\text{W}$
			Cathode DC	-	0.20	$^\circ\text{C}/\text{W}$
$R_{th(c-hs)}$	Contact thermal resistance	Clamping force 6.0kN With mounting compound	Per contact	-	0.018	$^\circ\text{C}/\text{W}$
T_{vj}	Virtual junction temperature	On-state (conducting)		-	125	$^\circ\text{C}$
T_{OP}/T_{stg}	Operating junction/storage temperature range			-40	125	$^\circ\text{C}$
F_m	Clamping force			5.0	6.0	kN

CHARACTERISTICS
 $T_j = 125^\circ\text{C}$ unless stated otherwise

Symbol	Parameter	Test Conditions	Min	Max.	Units
V_{TM}	On-state voltage	At 600A peak, $I_{G(ON)} = 2\text{A dc}$	-	2.75	V
I_{DM}	Peak off-state current	$V_{DRM} = 2500\text{V}$, $V_{RG} = 0\text{V}$	-	50	mA
I_{RRM}	Peak reverse current	At V_{RRM}	-	50	mA
V_{GT}	Gate trigger voltage	$V_D = 24\text{V}$, $I_T = 100\text{A}$, $T_j = 25^\circ\text{C}$	-	0.9	V
I_{GT}	Gate trigger current	$V_D = 24\text{V}$, $I_T = 100\text{A}$, $T_j = 25^\circ\text{C}$	-	1.0	A
I_{RGM}	Reverse gate cathode current	$V_{RGM} = 16\text{V}$, No gate/cathode resistor	-	50	mA
E_{ON}	Turn-on energy	$V_D = 2000\text{V}$, $I_T = 600\text{A}$, $di_T/dt = 300\text{A}/\mu\text{s}$ $I_{FG} = 20\text{A}$, rise time $< 1.0\mu\text{s}$	-	515	mJ
t_d	Delay time		-	1.5	μs
t_r	Rise time			3.0	μs
E_{OFF}	Turn-off energy	$I_T = 600\text{A}$, $V_{DM} = 2000\text{V}$, Snubber capacitor $C_S = 1.0\mu\text{F}$, $di_{GQ}/dt = 15\text{A}/\mu\text{s}$	-	1000	mJ
t_{gs}	Storage time		-	11.4	μs
t_{gf}	Fall time		-	1.5	μs
t_{gq}	Gate controlled turn-off time		-	12.9	μs
Q_{GQ}	Turn-off gate charge			1300	μC
Q_{GQT}	Total turn-off gate charge			2600	μC
I_{GQM}	Peak reverse gate current			190	A

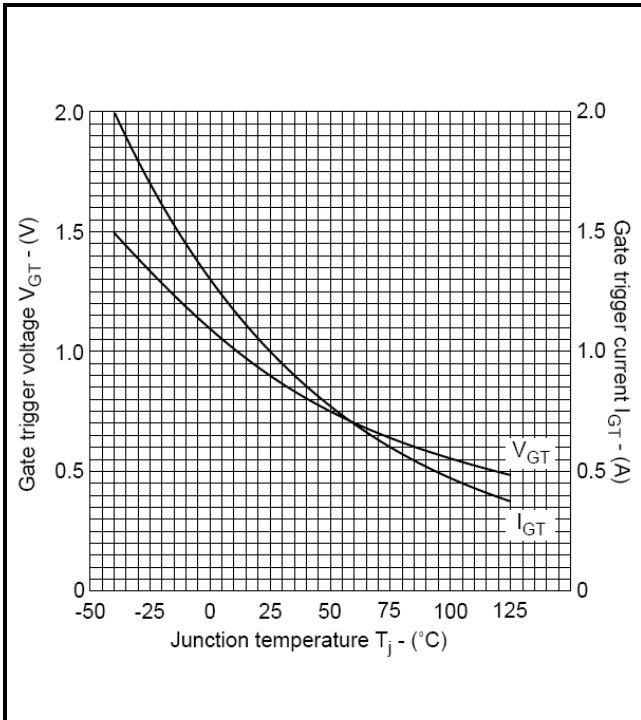

Fig.2 Maximum gate trigger voltage/current vs junction temperature

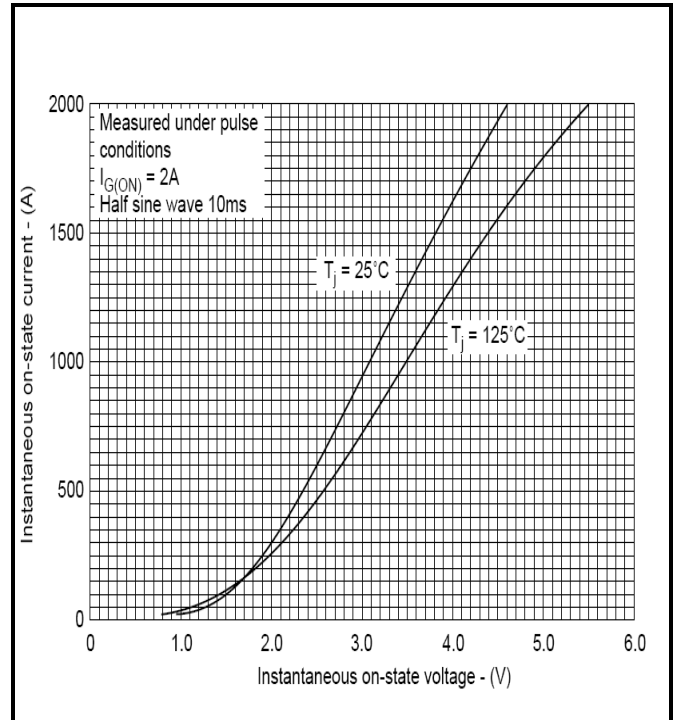

Fig.3 On-state characteristics

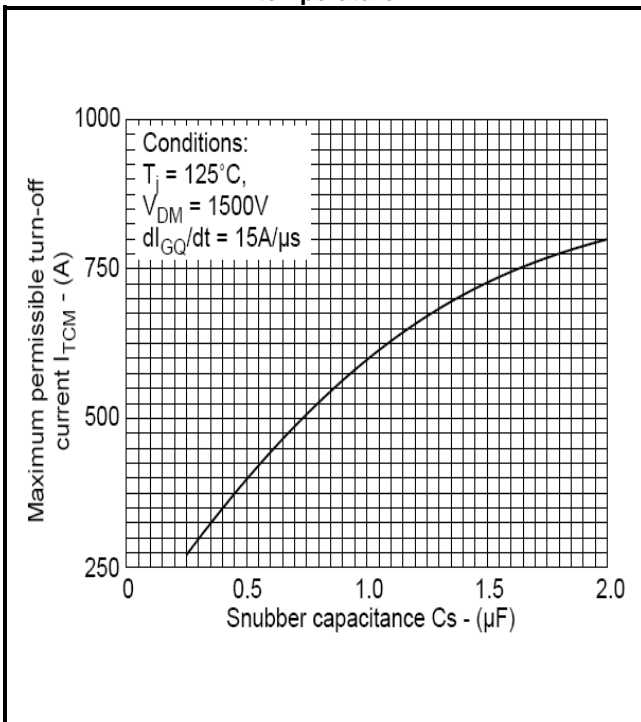

Fig.4 Maximum dependence of I_{TCM} on C_s

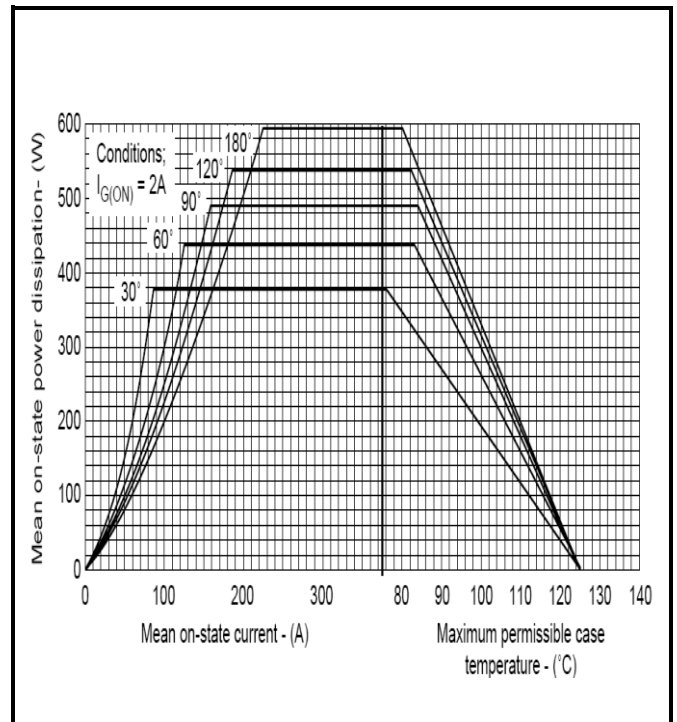

Fig.5 Steady state sinusoidal wave conduction loss – double side cooled

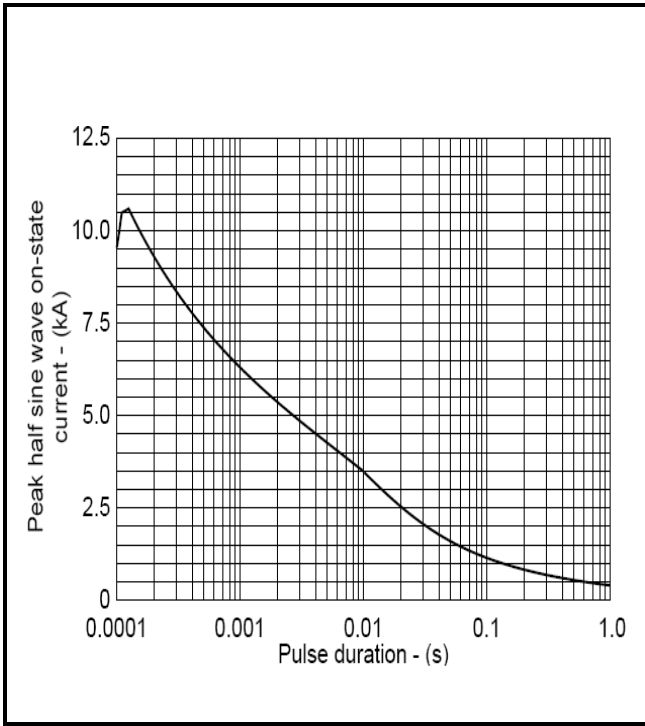

Fig.6 Surge (non-repetitive) on-state current vs time

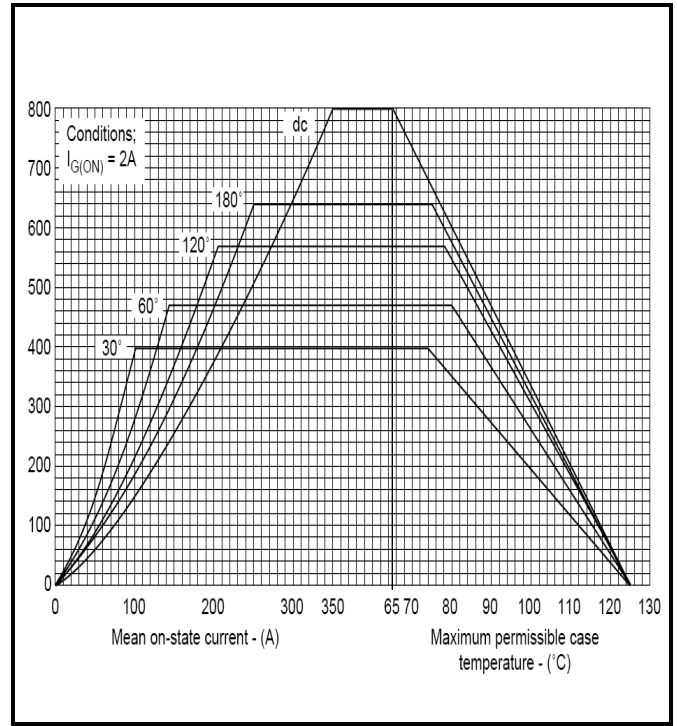

Fig.7 Steady state rectangular wave conduction loss – double side cooled

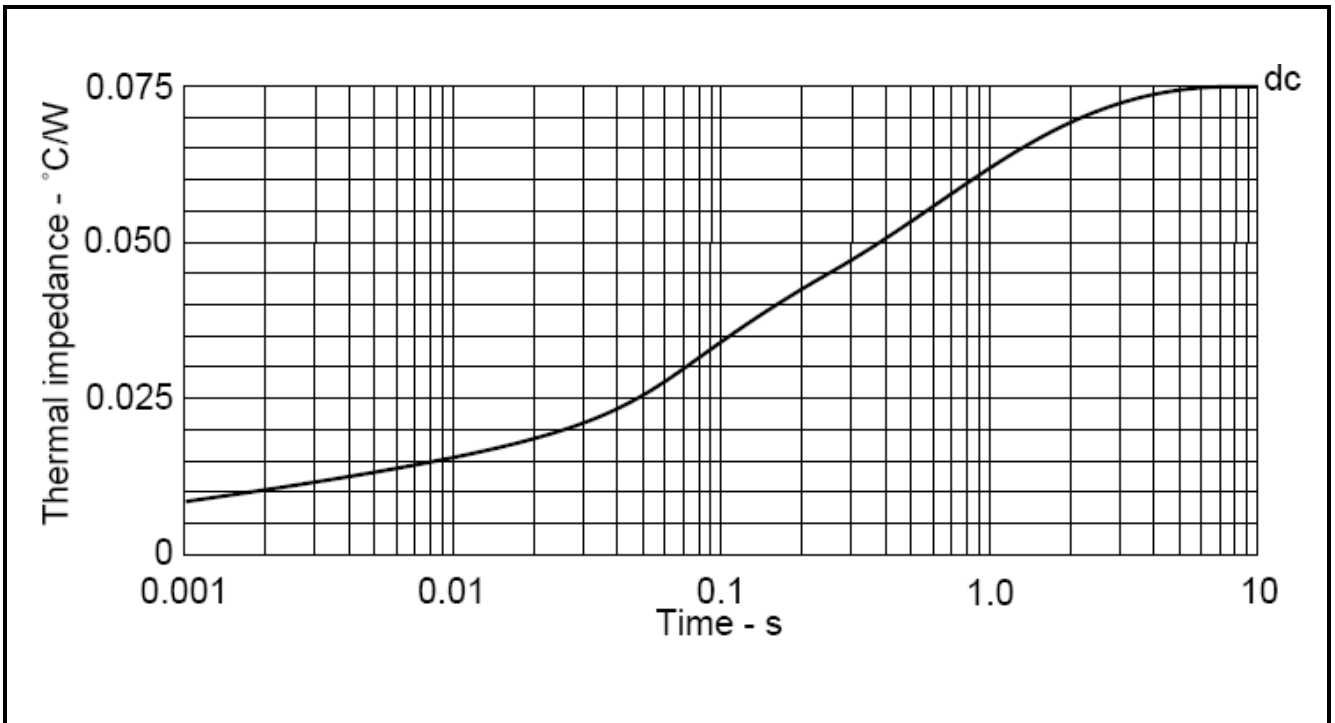

Fig.8 Maximum (limit) transient thermal impedance – junction to case (°C/kW) double side cooled

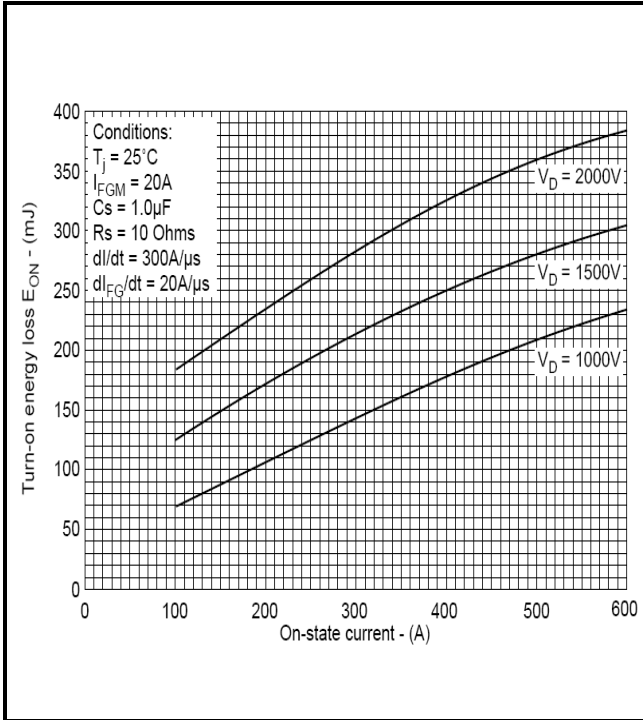

Fig.9 Turn-on energy vs on-state current

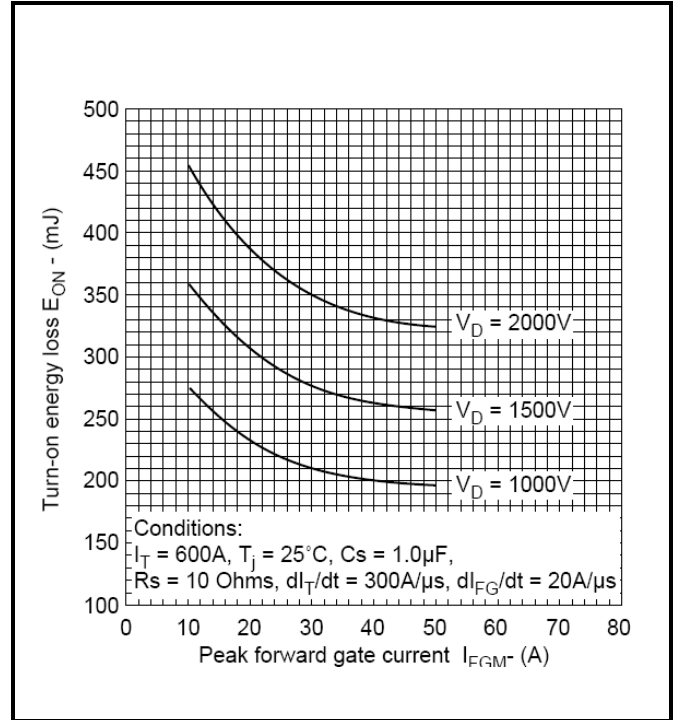

Fig.10 Turn-on energy vs peak forward gate current

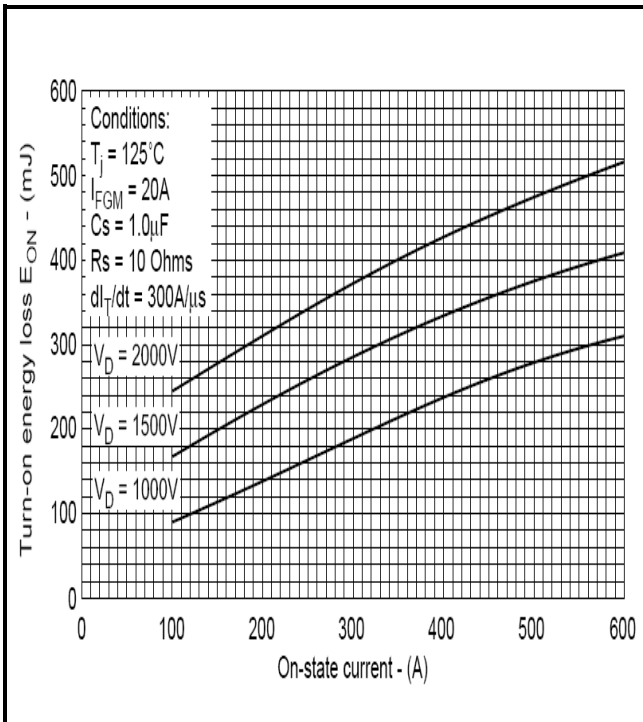

Fig.11 Turn-on energy vs on-state current

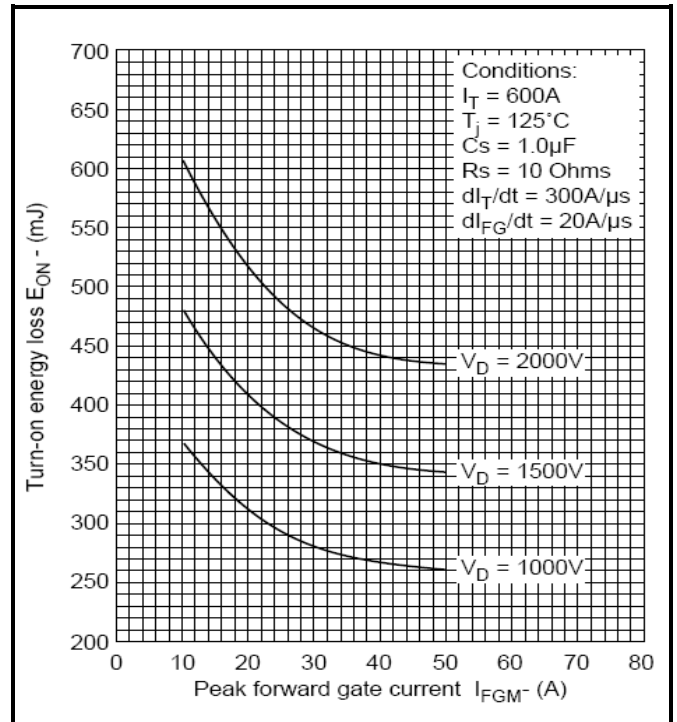

Fig.12 Turn-on energy vs peak forward gate current

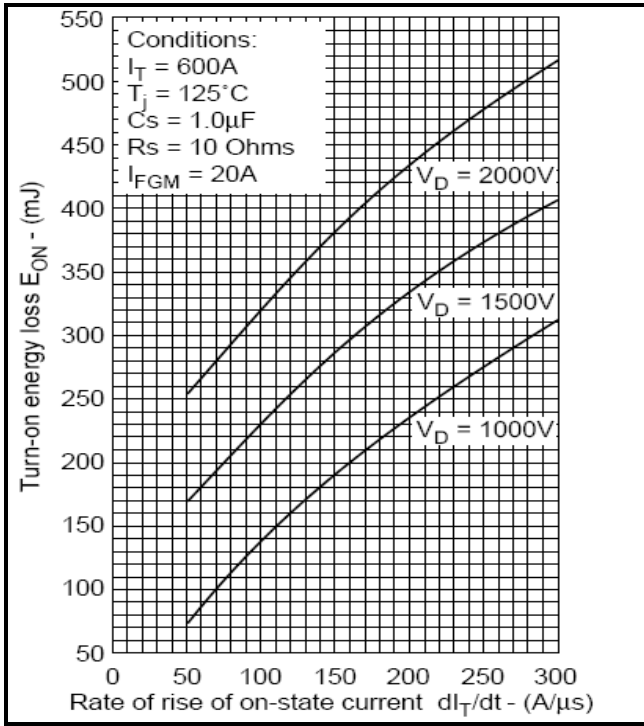

Fig.13 Turn-on energy vs rate of rise of on-state current

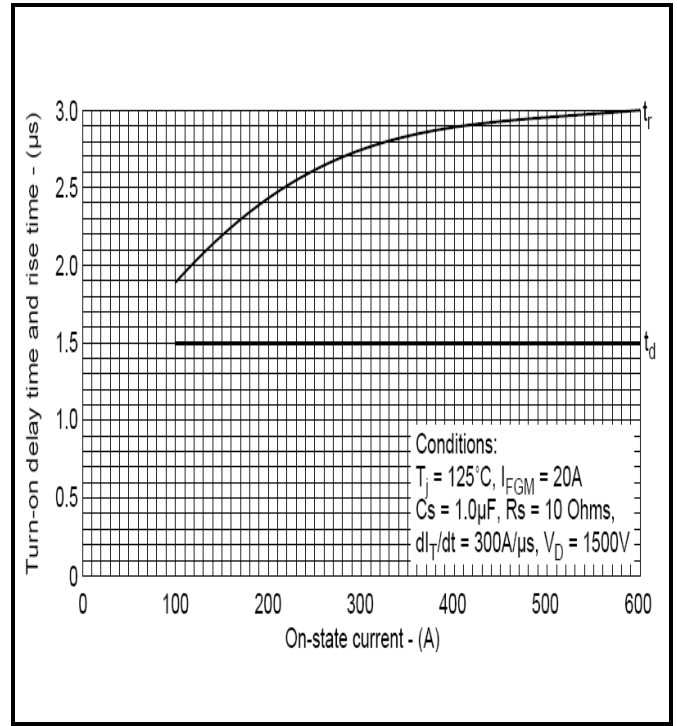

Fig.14 Delay time & rise time vs turn-on current

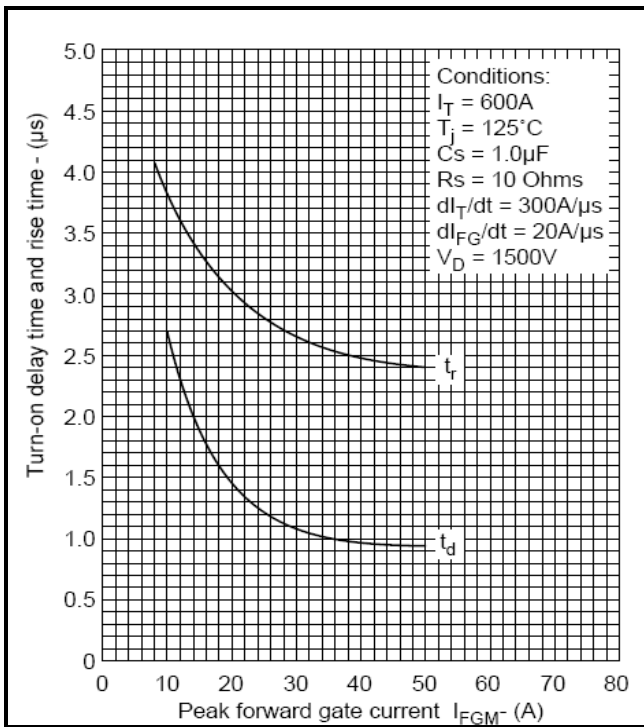

Fig.15 Delay time & rise time vs peak forward gate current

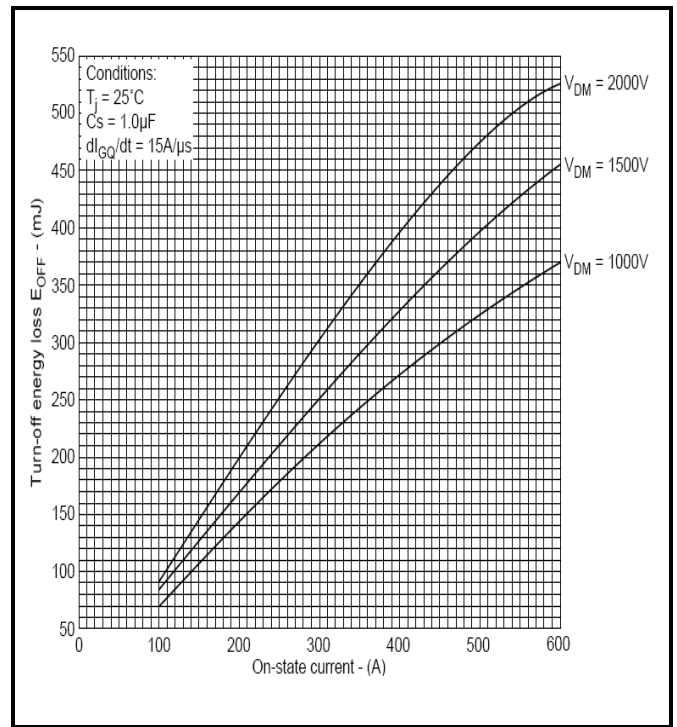

Fig.16 Turn-off energy vs on-state current

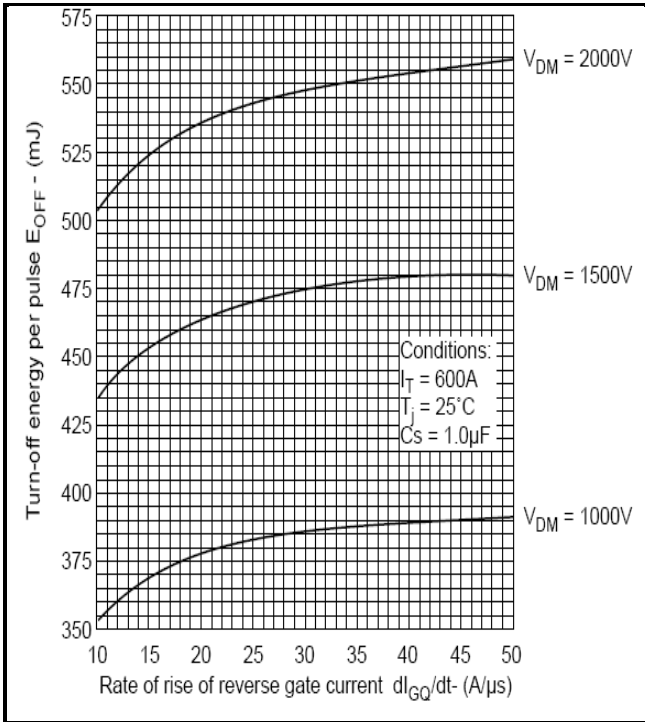

Fig.17 Turn-off energy vs rate of rise of reverse gate current

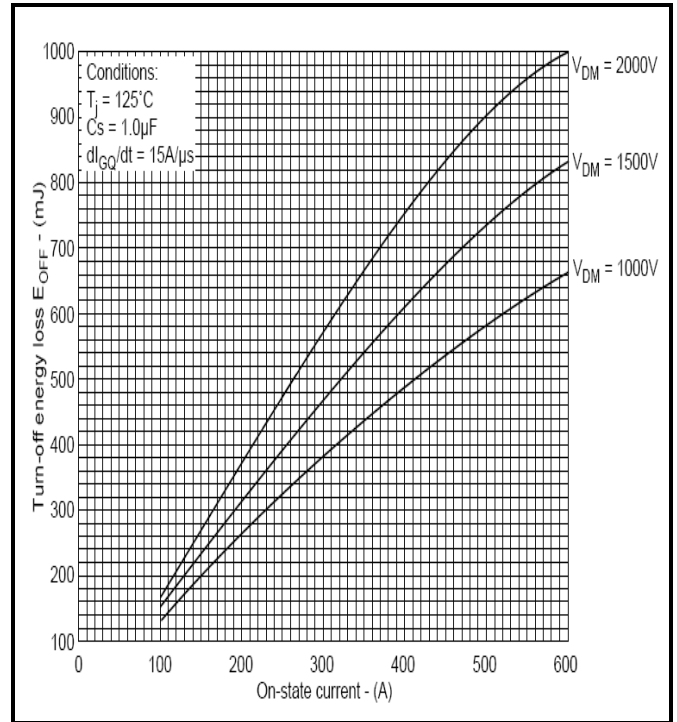

Fig.18 Turn-off energy vs on-state current

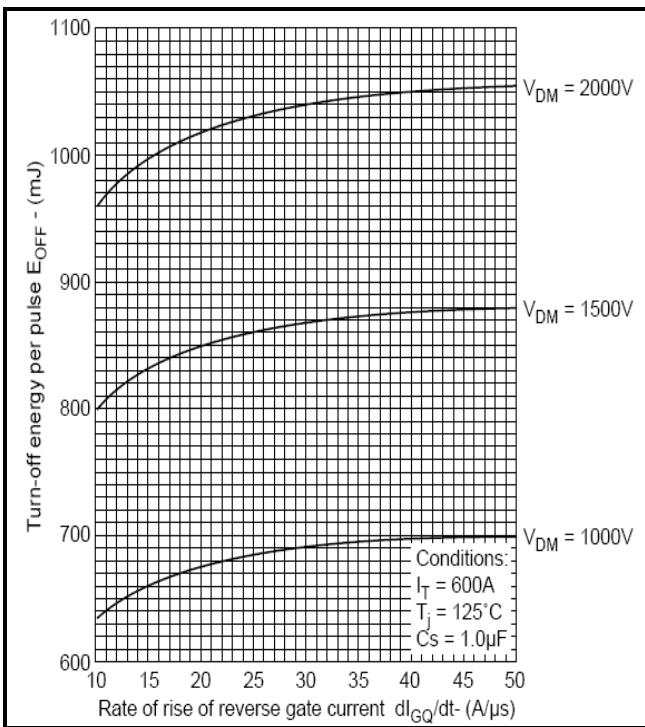

Fig.19 Turn-off energy vs rate of rise of reverse gate current

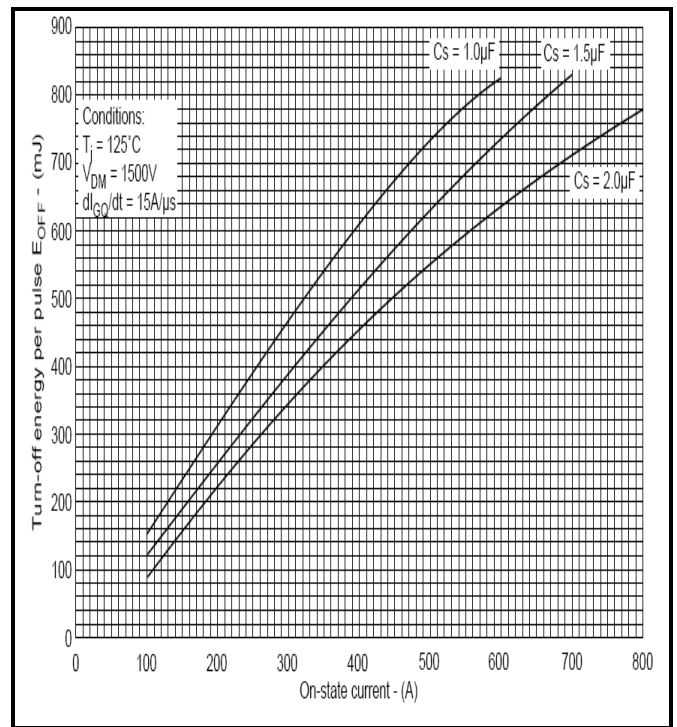

Fig.20 Turn-off energy vs on-state current

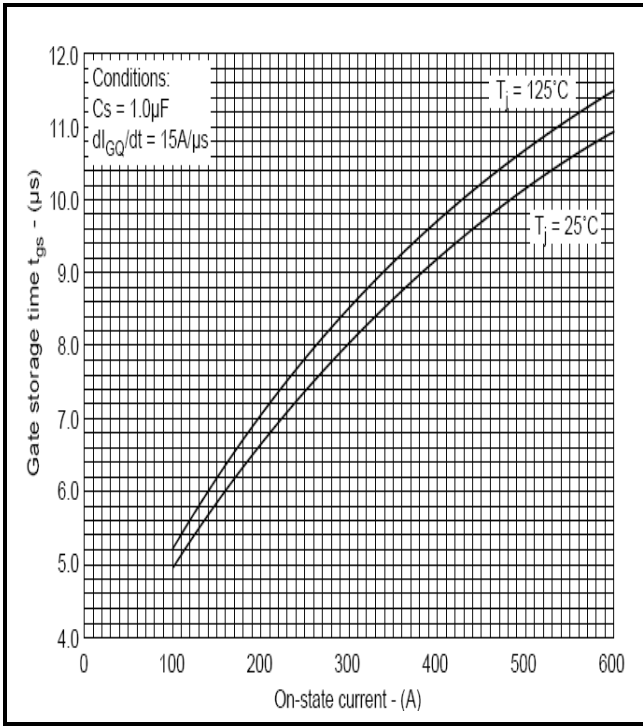

Fig.21 Gate storage time vs on-state current

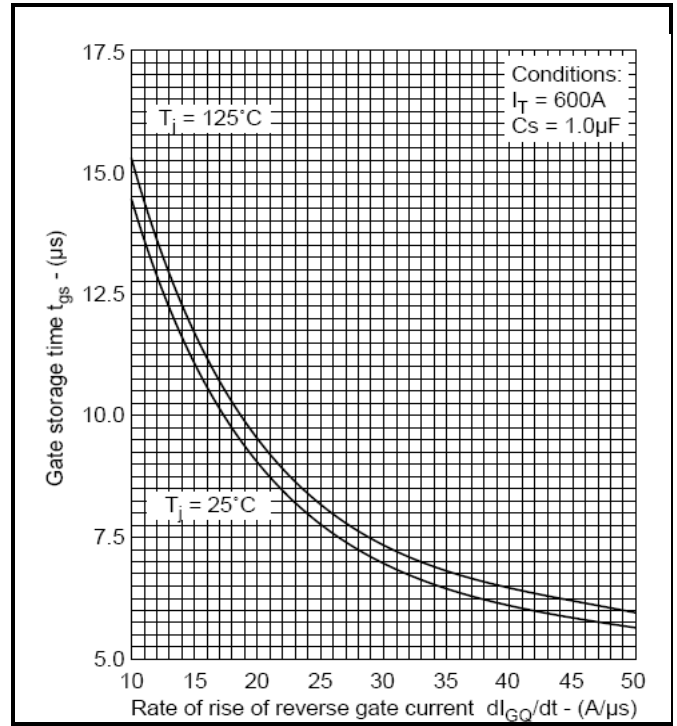

Fig.22 Gate storage time vs rate of rise of reverse gate current

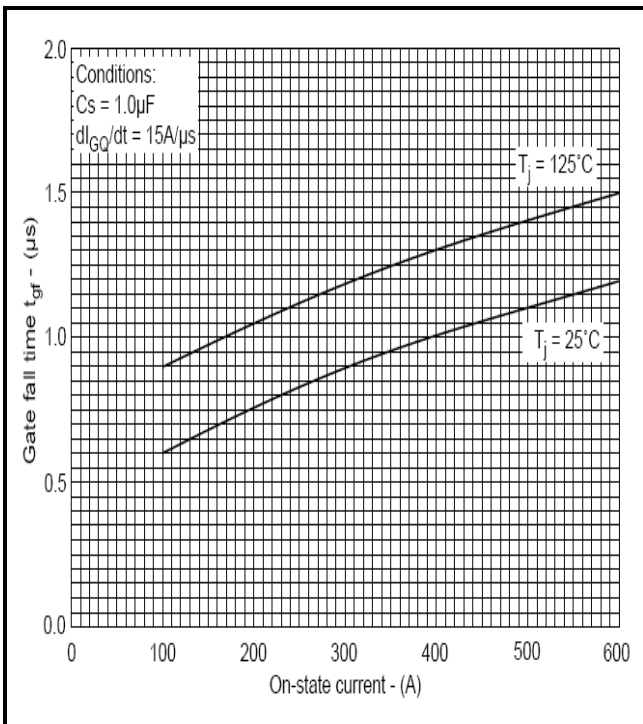

Fig.23 Gate fall time vs on-state current

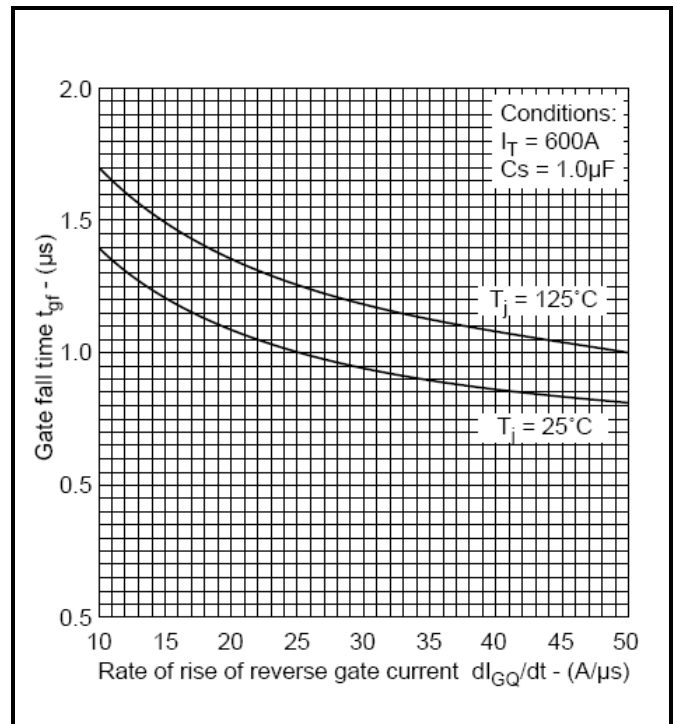

Fig.24 Gate fall time vs rate of rise of reverse gate current

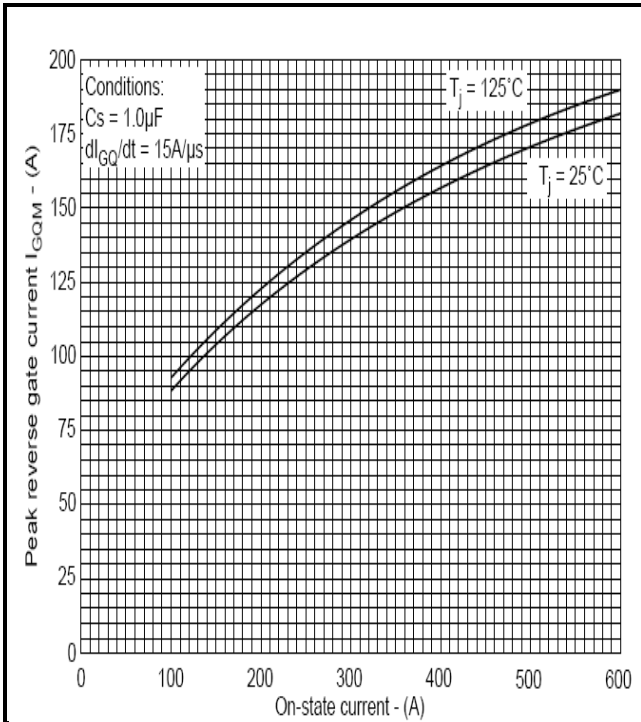

Fig.25 Peak reverse gate current vs turn-off current

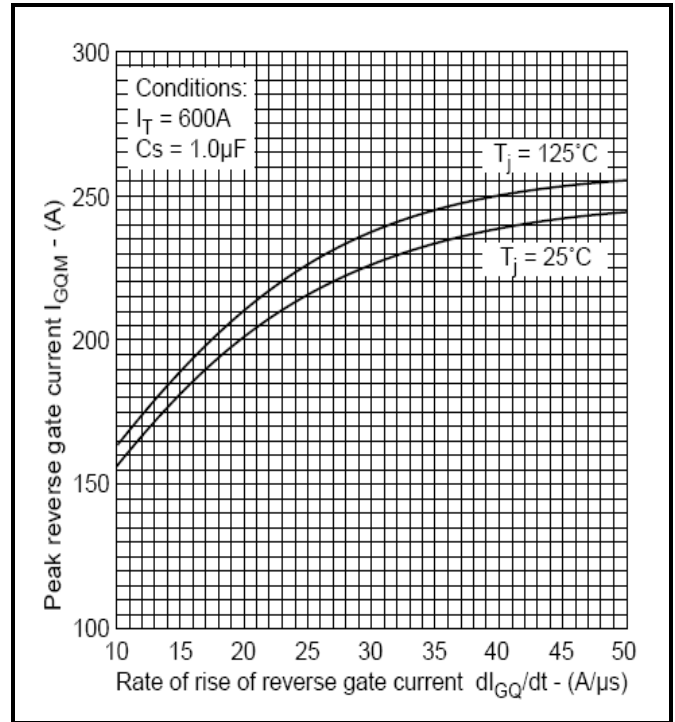

Fig.26 Peak reverse gate current vs rate of rise of reverse gate current

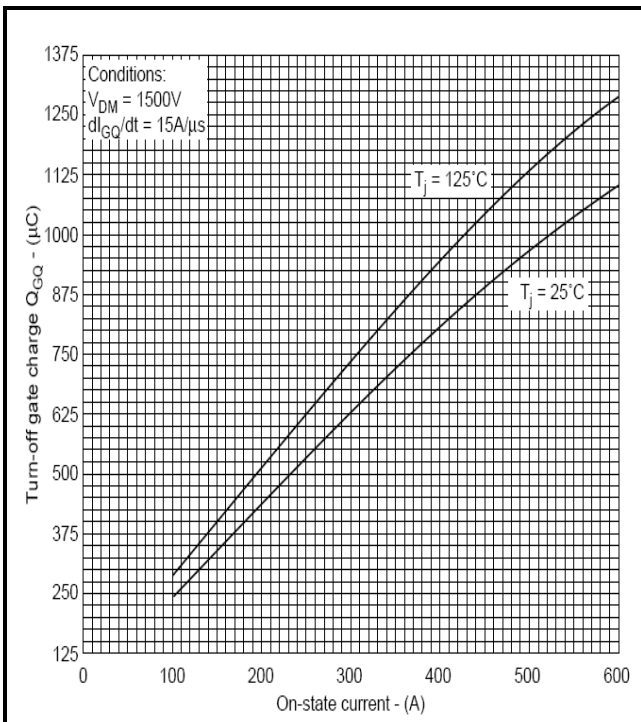

Fig.27 Turn-off gate charge vs on-state current

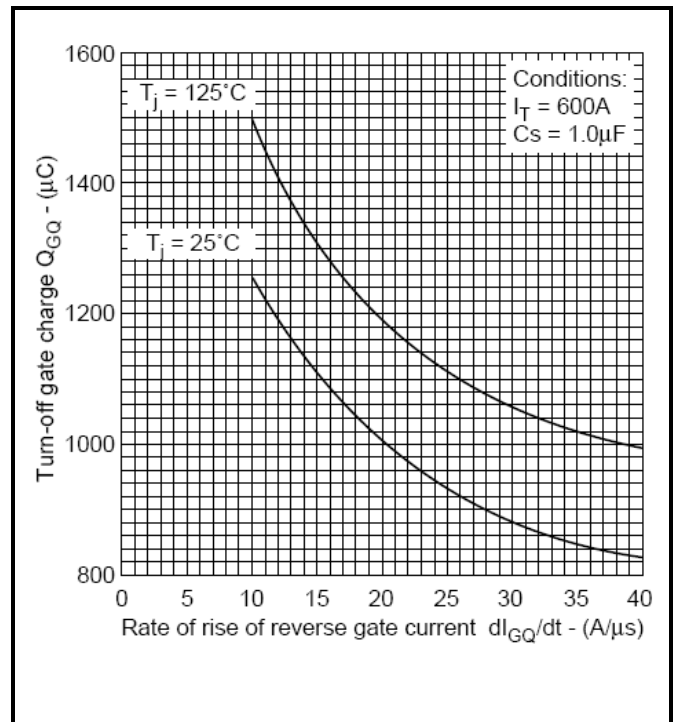

Fig.28 Turn-off gate charge vs rate of rise of reverse gate current

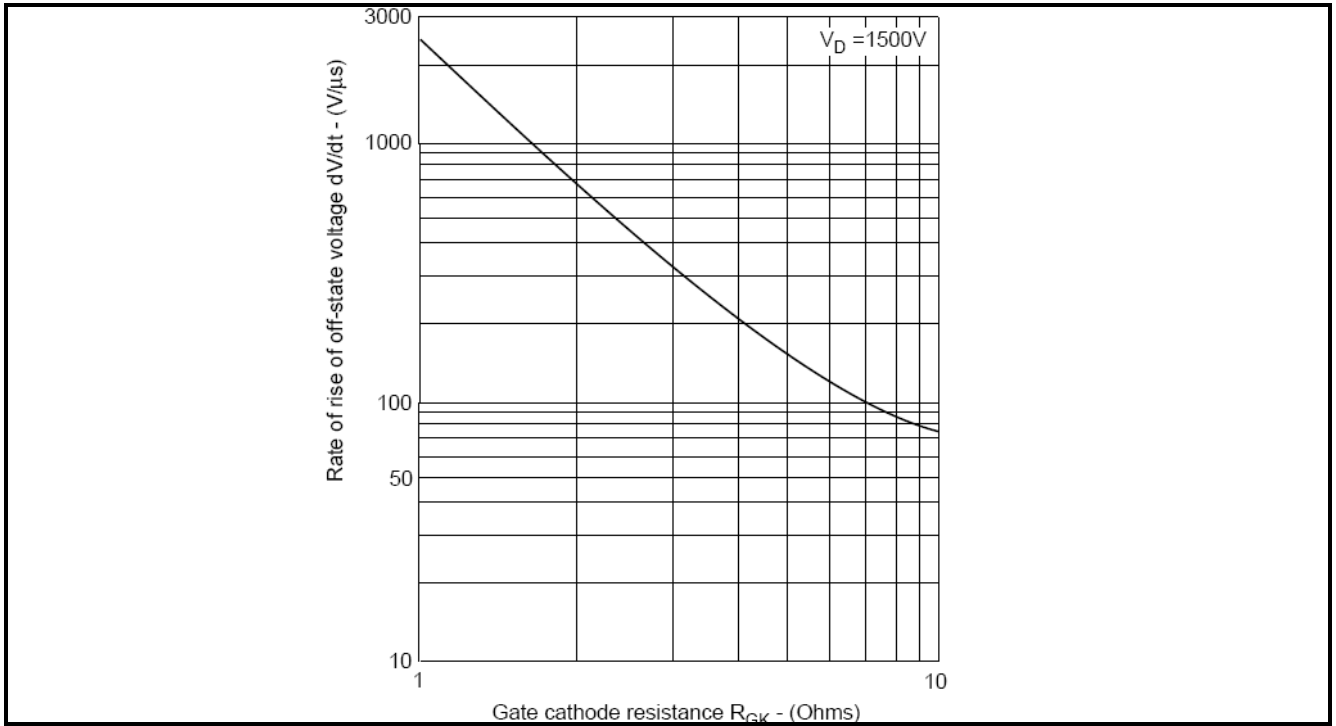
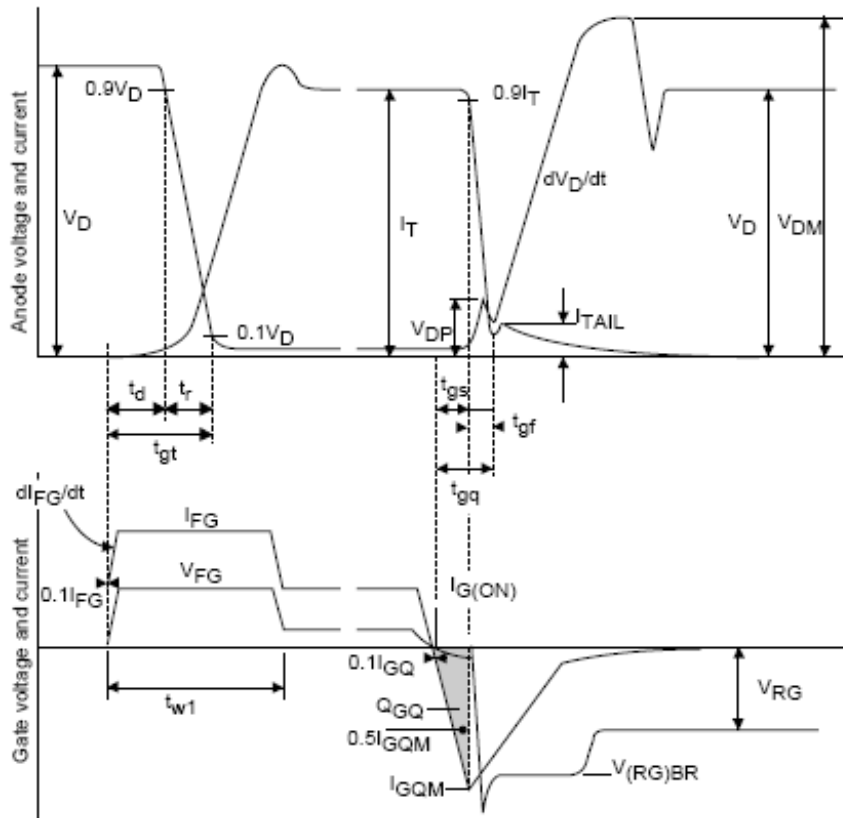

Fig.29 Rate of rise of off-state voltage vs gate cathode resistance



Recommended gate conditions:

- $I_{TCM} = 800A$
- $I_{FG} = 20A$
- $I_{G(ON)} = 2A$ d.c.
- $t_{w1(min)} = 10\mu s$
- $I_{GQM} = 190A$
- $di_{GQ}/dt = 15A/\mu s$
- $Q_{GQ} = 1300\mu C$
- $V_{RG(min)} = 2.0V$
- $V_{RG(max)} = 16V$

These are recommended Dynex Semiconductor conditions. Other conditions are permitted according to users gate drive specifications.

Fig.30 General switching waveforms

PACKAGE DETAILS

For further package information, please contact Customer Services. All dimensions in mm, unless stated otherwise. DO NOT SCALE.

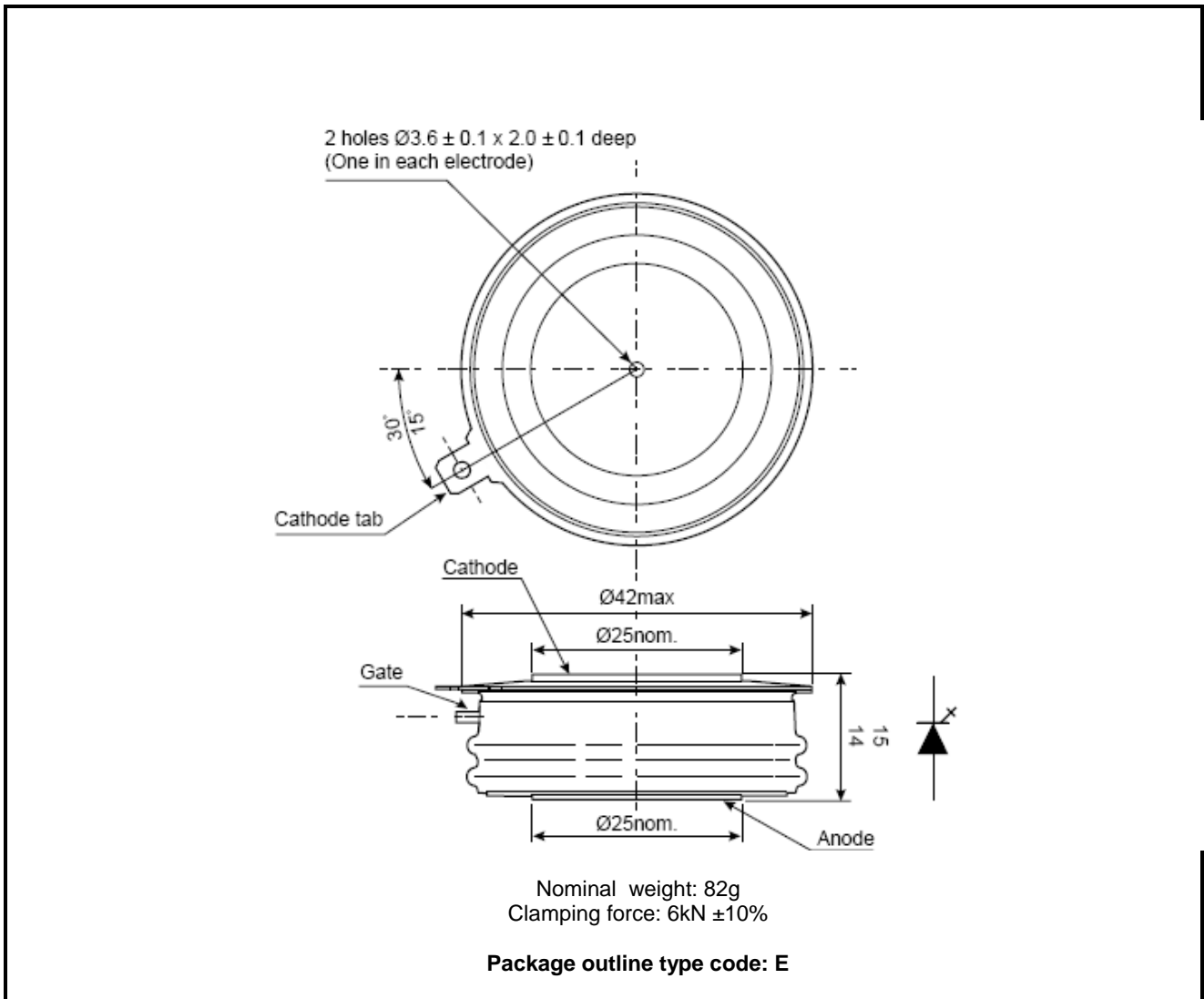

Fig.31 Package outline

POWER ASSEMBLY CAPABILITY

The Power Assembly group was set up to provide a support service for those customers requiring more than the basic semiconductor, and has developed a flexible range of heatsink and clamping systems in line with advances in device voltages and current capability of our semiconductors.

We offer an extensive range of air and liquid cooled assemblies covering the full range of circuit designs in general use today. The Assembly group offers high quality engineering support dedicated to designing new units to satisfy the growing needs of our customers.

Using the latest CAD methods our team of design and applications engineers aim to provide the Power Assembly Complete Solution (PACs).

HEATSINKS

The Power Assembly group has its own proprietary range of extruded aluminium heatsinks which have been designed to optimise the performance of Dynex semiconductors. Data with respect to air natural, forced air and liquid cooling (with flow rates) is available on request.

For further information on device clamps, heatsinks and assemblies, please contact your nearest sales representative or Customer Services.

Stresses above those listed in this data sheet may cause permanent damage to the device. In extreme conditions, as with all semiconductors, this may include potentially hazardous rupture of the package. Appropriate safety precautions should always be followed.



<http://www.dynexsemi.com>

e-mail: power_solutions@dynexsemi.com

HEADQUARTERS OPERATIONS
DYNEX SEMICONDUCTOR LTD
Doddington Road, Lincoln
Lincolnshire, LN6 3LF. United Kingdom.
Tel: +44(0)1522 500500
Fax: +44(0)1522 500550

CUSTOMER SERVICE
Tel: +44(0)1522 502753 / 502901. Fax: +44(0)1522 500020

© Dynex Semiconductor 2003 TECHNICAL DOCUMENTATION – NOT FOR
RESALE. PRODUCED IN UNITED KINGDOM.

This publication is issued to provide information only which (unless agreed by the Company in writing) may not be used, applied or reproduced for any purpose nor form part of any order or contract nor to be regarded as a representation relating to the products or services concerned. No warranty or guarantee express or implied is made regarding the capability, performance or suitability of any product or service. The Company reserves the right to alter without prior notice the specification, design or price of any product or service. Information concerning possible methods of use is provided as a guide only and does not constitute any guarantee that such methods of use will be satisfactory in a specific piece of equipment. It is the user's responsibility to fully determine the performance and suitability of any equipment using such information and to ensure that any publication or data used is up to date and has not been superseded. These products are not suitable for use in any medical products whose failure to perform may result in significant injury or death to the user. All products and materials are sold and services provided subject to the Company's conditions of sale, which are available on request.

All brand names and product names used in this publication are trademarks, registered trademarks or trade names of their respective owners.