

**FEATURES**

- Double Side Cooling
- High Surge Capability

**APPLICATIONS**

- Medium Voltage Soft Starts
- High Voltage Power Supplies
- Static Switches

**VOLTAGE RATINGS**

Part and Ordering Number	Repetitive Peak Voltages $V_{DRM}$ and $V_{RRM}$ V	Conditions
DCR820N65*	6500	$T_{vj} = -40^{\circ}\text{C}$ to $125^{\circ}\text{C}$ , $I_{DRM} = I_{RRM} = 200\text{mA}$ , $V_{DRM}, V_{RRM} t_p = 10\text{ms}$ , $V_{DSM} \& V_{RSM} =$ $V_{DRM} \& V_{RRM} + 100\text{V}$ respectively
DCR820N60	6000	
DCR820N55	5500	
DCR820N50	5000	

Lower voltage grades available.  
 6200V @  $-40^{\circ}\text{C}$ , 6500V @  $0^{\circ}\text{C}$

**ORDERING INFORMATION**

When ordering, select the required part number shown in the Voltage Ratings selection table.

For example:

**DCR820N65**

Note: Please use the complete part number when ordering and quote this number in any future correspondence relating to your order.

**KEY PARAMETERS**

$V_{DRM}$	<b>6500V</b>
$I_{T(AV)}$	<b>820A</b>
$I_{TSM}$	<b>12000A</b>
$dV/dt^*$	<b>1500V/<math>\mu\text{s}</math></b>
$di/dt$	<b>200A/<math>\mu\text{s}</math></b>

\* Higher  $dV/dt$  selections available

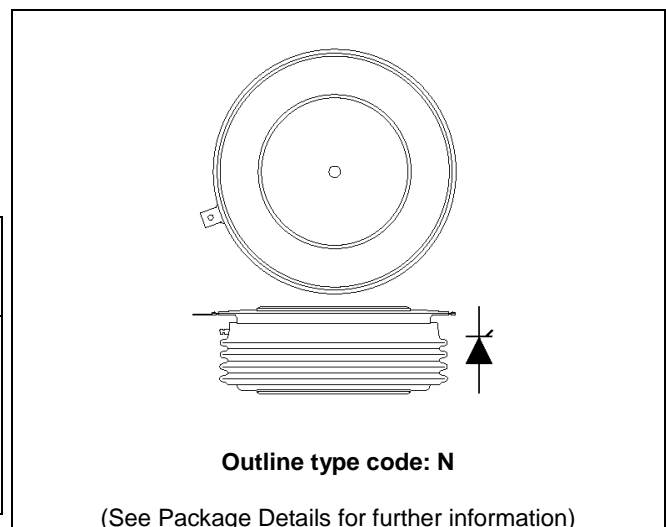

**Fig. 1 Package outline**

## CURRENT RATINGS

$T_{case} = 60^{\circ}\text{C}$  unless stated otherwise

Symbol	Parameter	Test Conditions	Max.	Units
<b>Double Side Cooled</b>				
$I_{T(AV)}$	Mean on-state current	Half wave resistive load	820	A
$I_{T(RMS)}$	RMS value	-	1288	A
$I_T$	Continuous (direct) on-state current	-	1090	A

## SURGE RATINGS

Symbol	Parameter	Test Conditions	Max.	Units
$I_{TSM}$	Surge (non-repetitive) on-state current	10ms half sine, $T_{case} = 125^{\circ}\text{C}$	12.0	kA
$I^2t$	$I^2t$ for fusing	$V_R = 0$	0.72	$\text{MA}^2\text{s}$

## THERMAL AND MECHANICAL RATINGS

Symbol	Parameter	Test Conditions	Min.	Max.	Units	
$R_{th(j-c)}$	Thermal resistance – junction to case	Double side cooled	DC	-	0.0221	$^{\circ}\text{C/W}$
		Single side cooled	Anode DC	-	0.041	$^{\circ}\text{C/W}$
			Cathode DC	-	0.0516	$^{\circ}\text{C/W}$
$R_{th(c-h)}$	Thermal resistance – case to heatsink	Clamping force 23 kN (with mounting compound)	Double side	-	0.004	$^{\circ}\text{C/W}$
			Single side	-	0.008	$^{\circ}\text{C/W}$
$T_{vj}$	Virtual junction temperature	Blocking $V_{DRM} / V_{RRM}$	-	125	$^{\circ}\text{C}$	
$T_{stg}$	Storage temperature range		-55	125	$^{\circ}\text{C}$	
$F_m$	Clamping force		20.0	25.0	kN	

**DYNAMIC CHARACTERISTICS**

Symbol	Parameter	Test Conditions	Min.	Max.	Units	
$I_{RRM}/I_{DRM}$	Peak reverse and off-state current	At $V_{RRM}/V_{DRM}$ , $T_{case} = 125^{\circ}C$	-	200	mA	
$dV/dt$	Max. linear rate of rise of off-state voltage	To 67% $V_{DRM}$ , $T_j = 125^{\circ}C$ , gate open	-	1500	V/ $\mu s$	
$di/dt$	Rate of rise of on-state current	From 67% $V_{DRM}$ to $2x I_{T(AV)}$	Repetitive 50Hz	-	100	A/ $\mu s$
		Gate source 30V, 10 $\Omega$ , $t_r < 0.5\mu s$ , $T_j = 125^{\circ}C$	Non-repetitive	-	200	A/ $\mu s$
$V_{T(TO)}$	Threshold voltage – Low level	100A to 870A at $T_{case} = 125^{\circ}C$	-	1.0	V	
	Threshold voltage – High level	870A to 3000A at $T_{case} = 125^{\circ}C$	-	1.1847	V	
$r_T$	On-state slope resistance – Low level	100A to 870A at $T_{case} = 125^{\circ}C$	-	1.1429	m $\Omega$	
	On-state slope resistance – High level	870A to 3000A at $T_{case} = 125^{\circ}C$	-	0.9472	m $\Omega$	
$t_{gd}$	Delay time	$V_D = 67\% V_{DRM}$ , gate source 30V, 10 $\Omega$ $t_r = 0.5\mu s$ , $T_j = 25^{\circ}C$	-	3	$\mu s$	
$t_q$	Turn-off time	$T_j = 125^{\circ}C$ , $I_{peak} = 1000A$ , $t_p = 1000\mu s$ , $V_{RM} = 100V$ , $di/dt = -5A/\mu s$ , $dV_{DR}/dt = 20V/\mu s$ linear to 2500V	600	1000	$\mu s$	
$I_{RR}$	Reverse recovery current	$I_T = 1000A$ , $t_p = 1000\mu s$ , $T_j = 125^{\circ}C$ , $di/dt = -5A/\mu s$ , $V_R = 100V$	90	120	A	
$Q_S$	Stored charge		2500	4000	$\mu C$	
$I_L$	Latching current	$T_j = 25^{\circ}C$ , $V_D = 5V$	-	3	A	
$I_H$	Holding current	$T_j = 25^{\circ}C$ , $R_{G-K} = \infty$ , $I_{TM} = 500A$ , $I_T = 5A$	-	300	mA	

**GATE TRIGGER CHARACTERISTICS AND RATINGS**

Symbol	Parameter	Test Conditions	Max.	Units
$V_{GT}$	Gate trigger voltage	$V_{DRM} = 5V, T_{case} = 25^{\circ}C$	1.5	V
$V_{GD}$	Gate non-trigger voltage	At 50% $V_{DRM}, T_{case} = 125^{\circ}C$	0.4	V
$I_{GT}$	Gate trigger current	$V_{DRM} = 5V, T_{case} = 25^{\circ}C$	350	mA
$I_{GD}$	Gate non-trigger current	At 50% $V_{DRM}, T_{case} = 125^{\circ}C$	15	mA

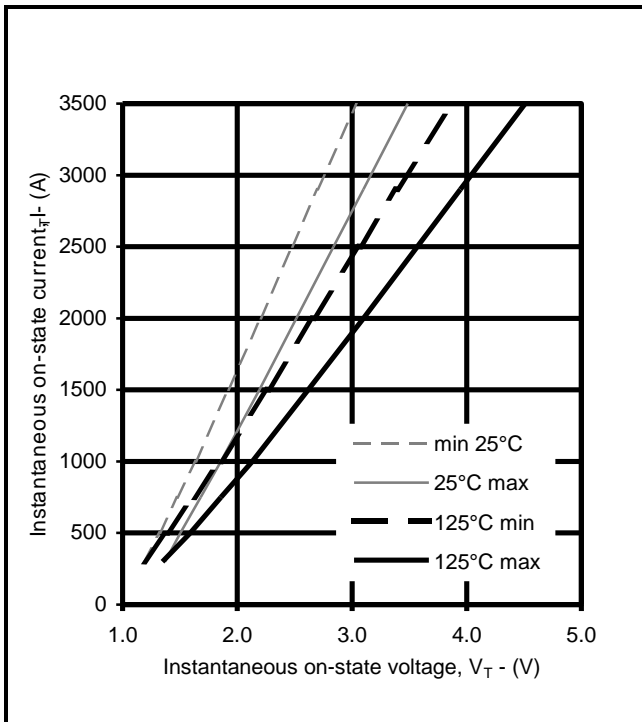
**CURVES**

**Fig.2 Maximum & minimum on-state characteristics**
 **$V_{TM}$  EQUATION**

$$V_{TM} = A + B \ln(I_T) + C \cdot I_T + D \cdot \sqrt{I_T}$$

 Where  $A = 0.874878$ 
 $B = 0.001945$ 
 $C = 0.000808$ 
 $D = 0.013372$ 

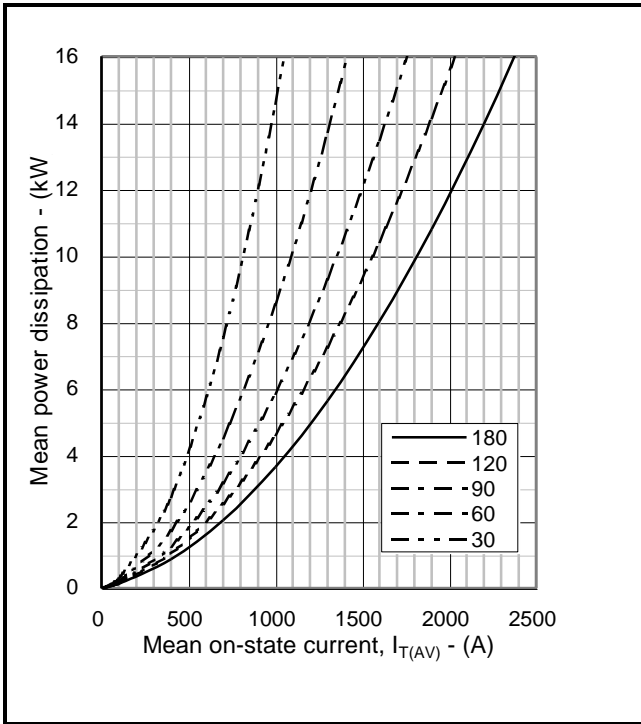
 these values are valid for  $T_j = 125^{\circ}C$  for  $I_T$  300A to 3500A



**Fig.3 On-state power dissipation – sine wave**

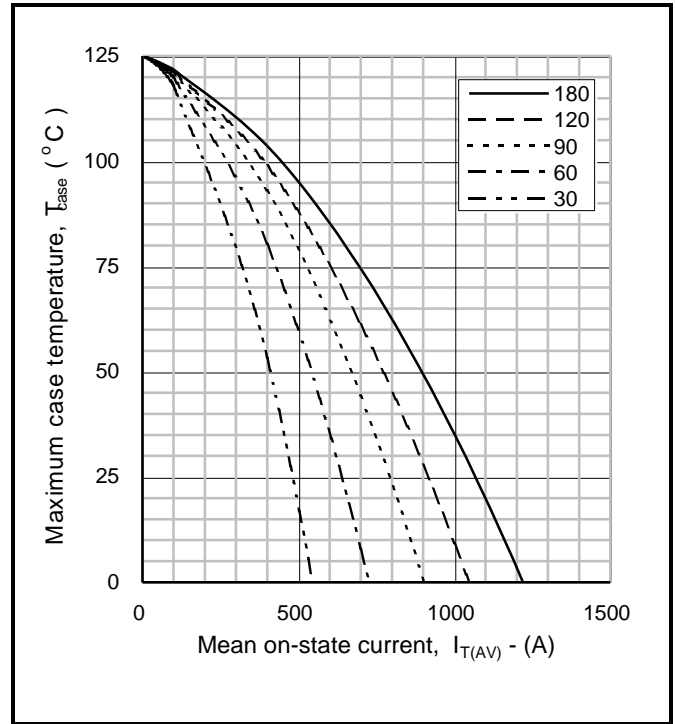

**Fig.4 Maximum permissible case temperature, double side cooled – sine wave**

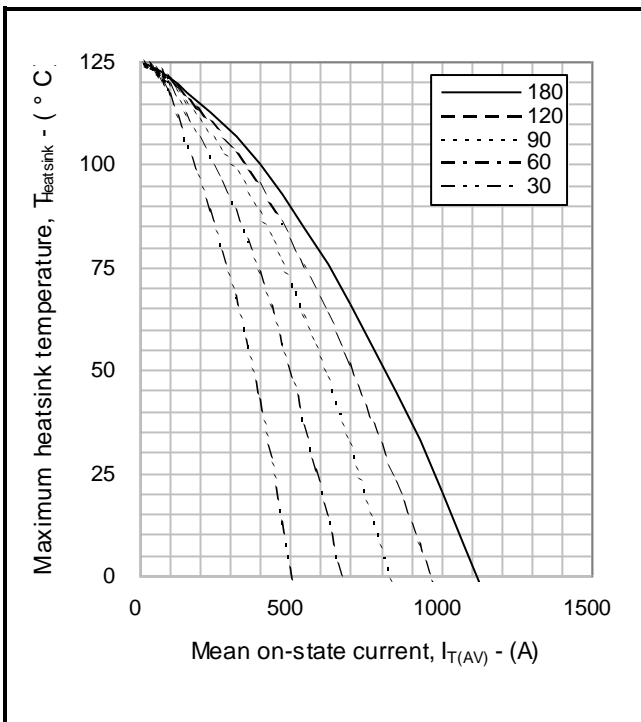

**Fig.5 Maximum permissible heatsink temperature, double side cooled – sine wave**

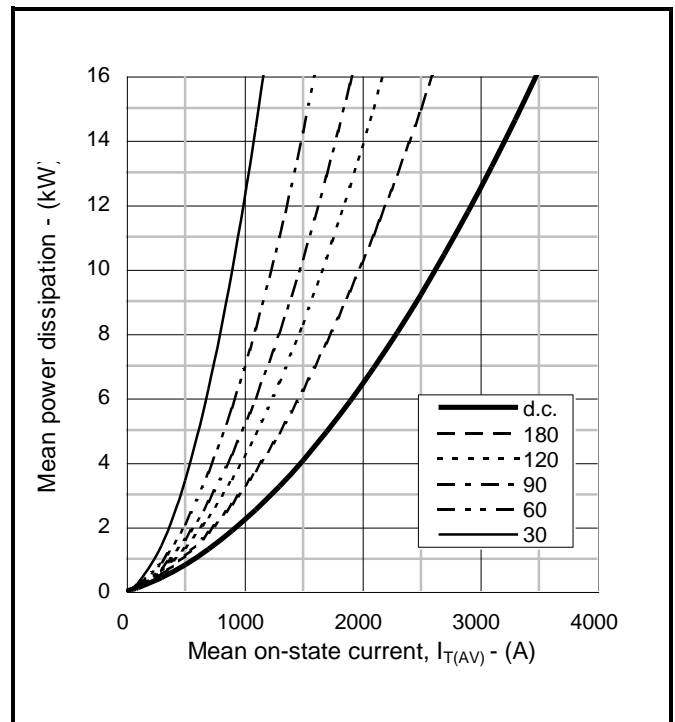

**Fig.6 On-state power dissipation – rectangular wave**

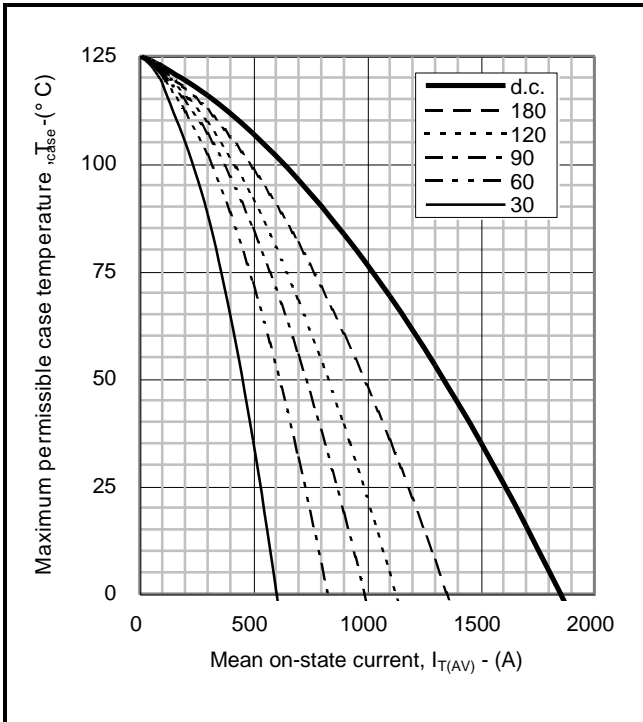

Fig.7 Maximum permissible case temperature, double side cooled – rectangular wave

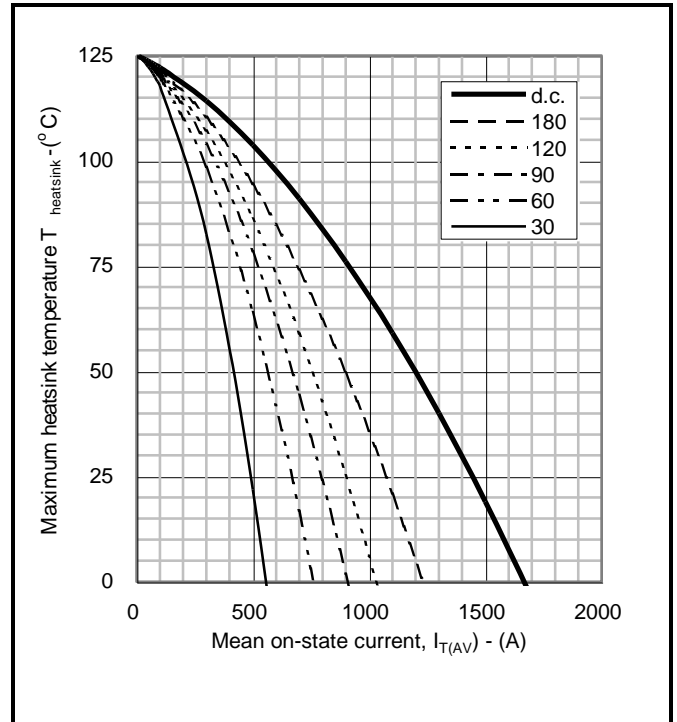

Fig.8 Maximum permissible heatsink temperature, double side cooled – rectangular wave

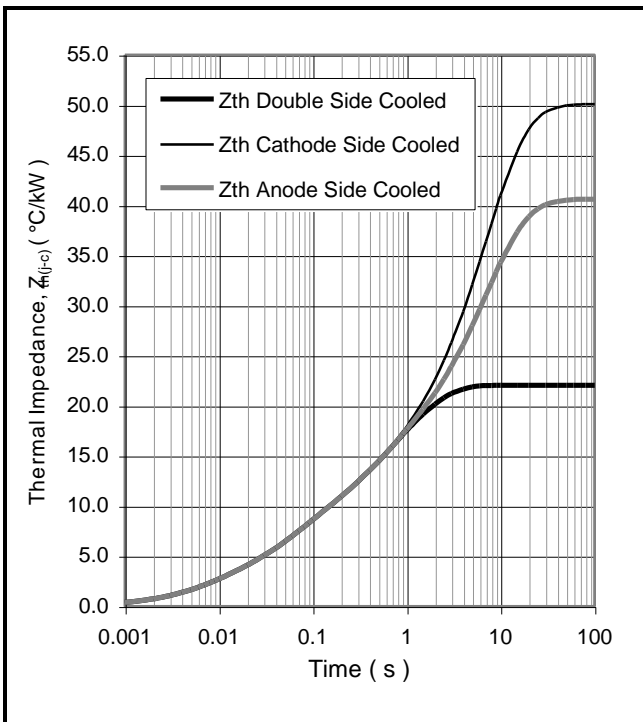

Fig.9 Maximum (limit) transient thermal impedance – junction to case (°C/kW)

		1	2	3	4
Double side cooled	R <sub>i</sub> (°C/kW)	3.4733	4.9047	9.1463	4.5220
	T <sub>i</sub> (s)	0.1457	0.0166	1.2832	0.3767
Anode side cooled	R <sub>i</sub> (°C/kW)	7.6674	5.0530	9.7355	27.5992
	T <sub>i</sub> (s)	0.2241	0.0169	4.0566	8.2780
Cathode side cooled	R <sub>i</sub> (°C/kW)	6.0393	4.2782	5.1301	25.0874
	T <sub>i</sub> (s)	0.1356	0.0143	0.6594	7.2358

$$Z_{th} = \sum_{i=1}^{i=4} [R_i \times (1 - \exp(-T / T_i))]$$

**ΔR<sub>th(j-c)</sub> Conduction**

Tables show the increments of thermal resistance R<sub>th(j-c)</sub> when the device operates at conduction angles other than d.c.

θ°	Double side cooling		Anode Side Cooling		Cathode Sided Cooling	
	sine.	rect.	sine.	rect.	sine.	rect.
180	3.03	2.07	3.03	2.07	3.12	2.12
120	3.49	2.95	3.49	2.95	3.61	3.04
90	3.99	3.43	3.99	3.43	4.13	3.54
60	4.43	3.94	4.43	3.94	4.60	4.08
30	4.77	4.49	4.76	4.48	4.96	4.66
15	4.92	4.77	4.92	4.77	5.13	4.97

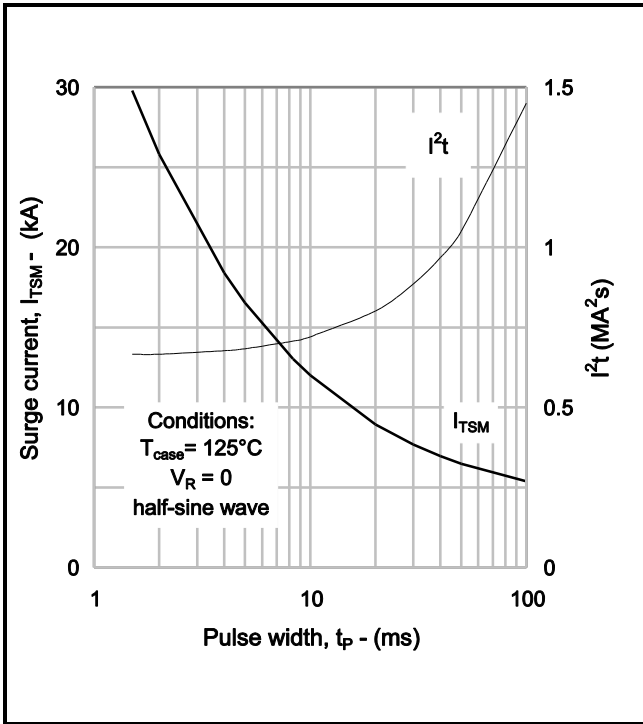

Fig.10 Single-cycle surge current

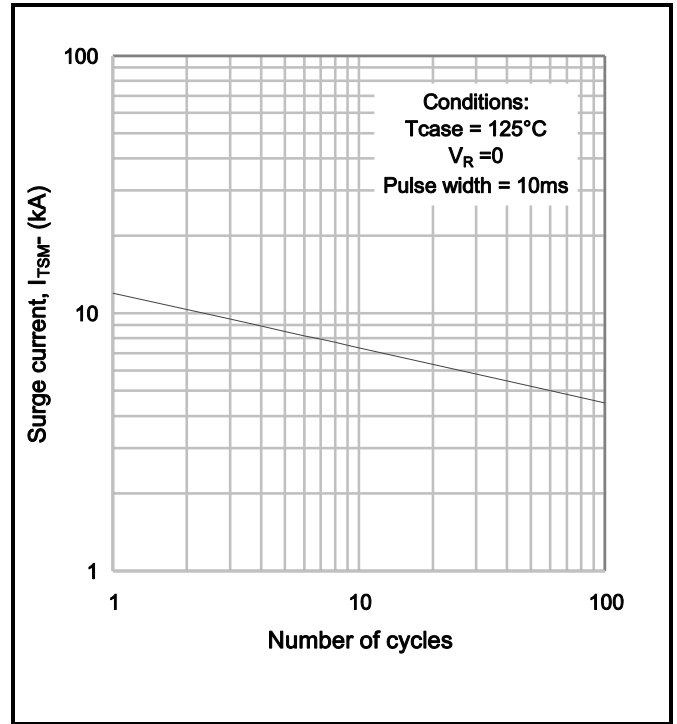

Fig.11 Multi-cycle surge current

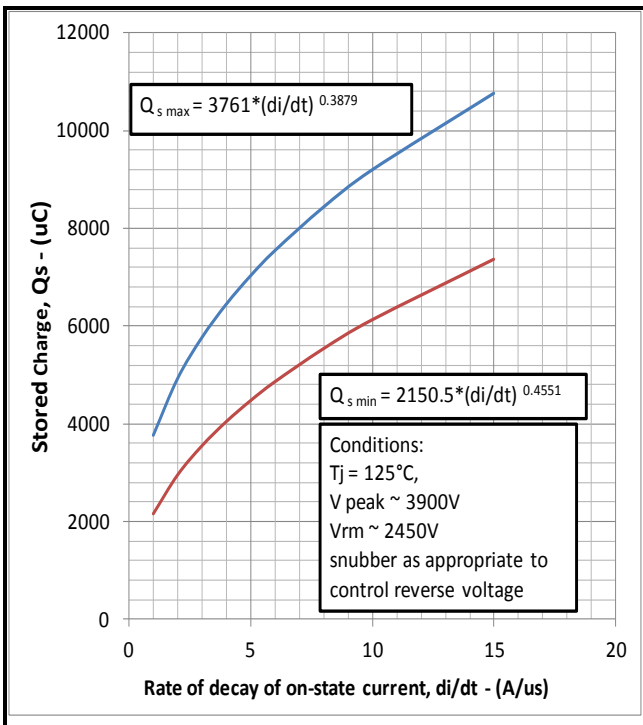

Fig.12 Stored charge

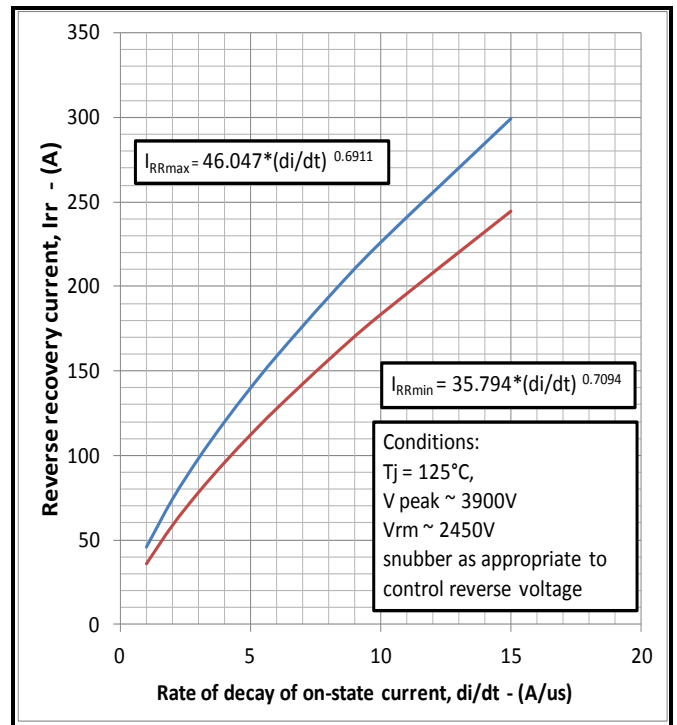

Fig.13 Reverse recovery current

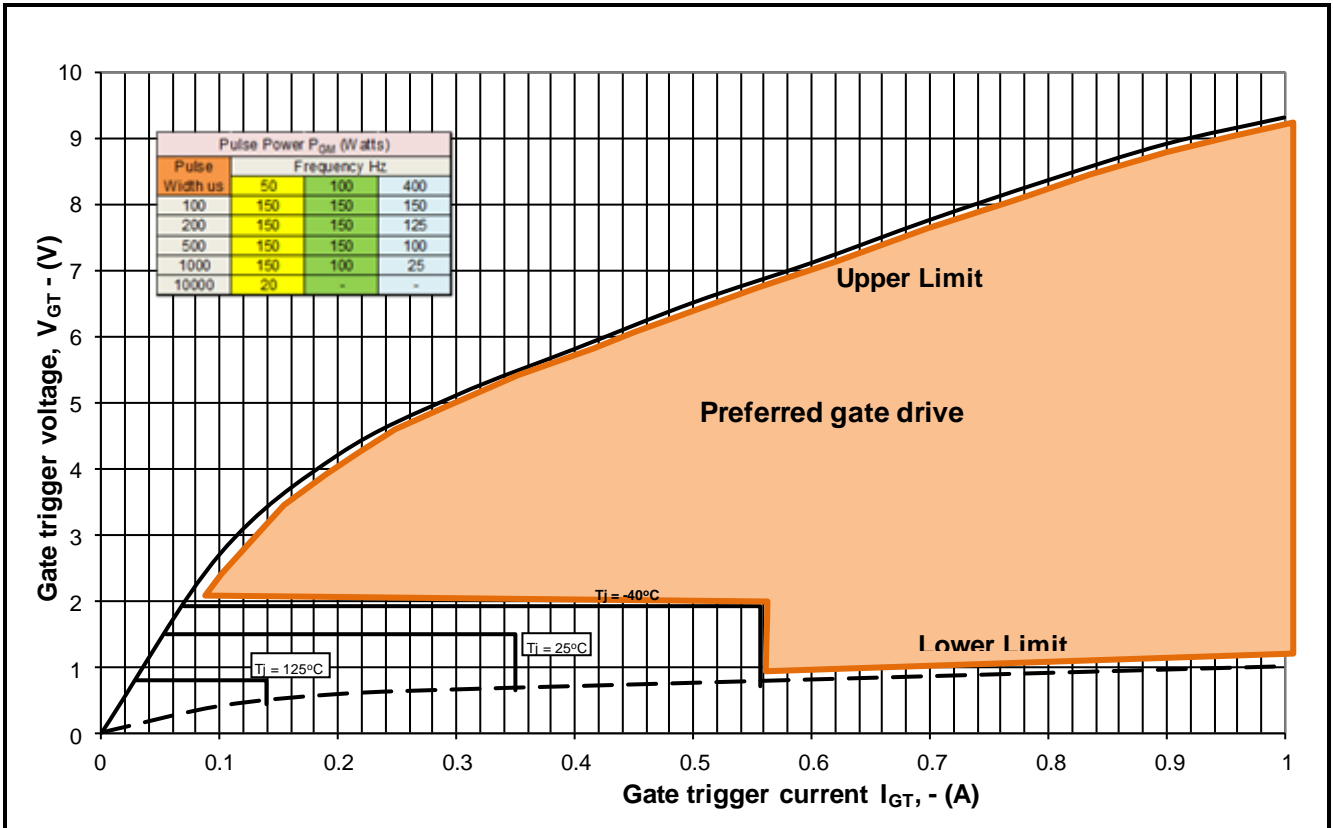

Fig14 Gate Characteristics

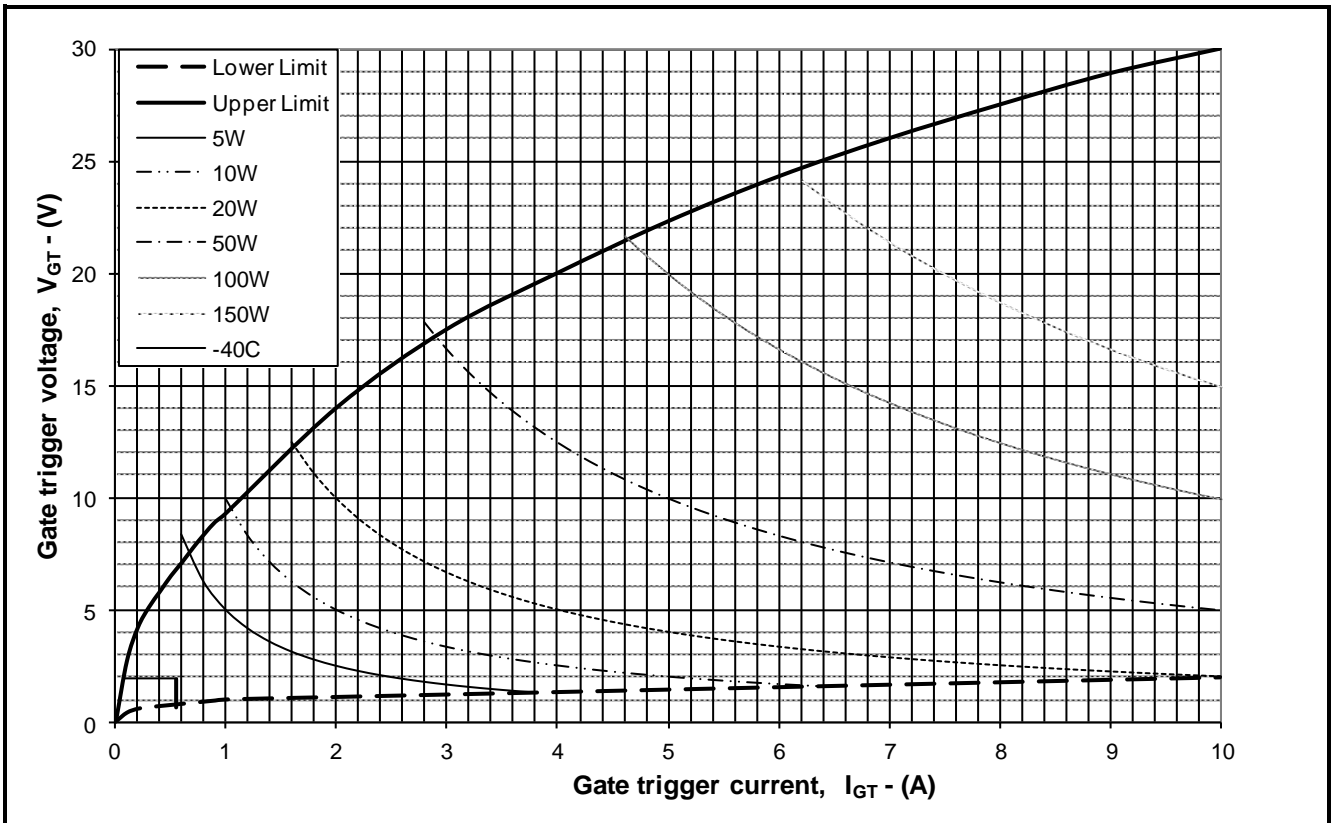
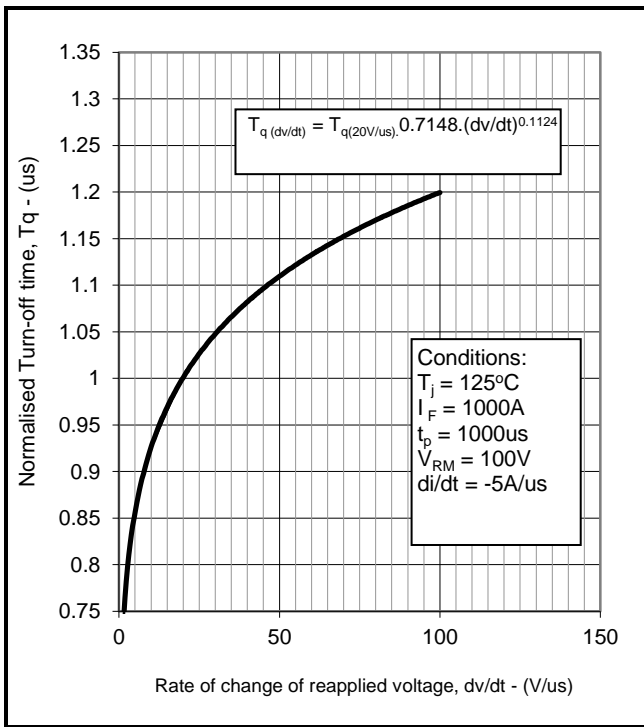

Fig. 15 Gate characteristics

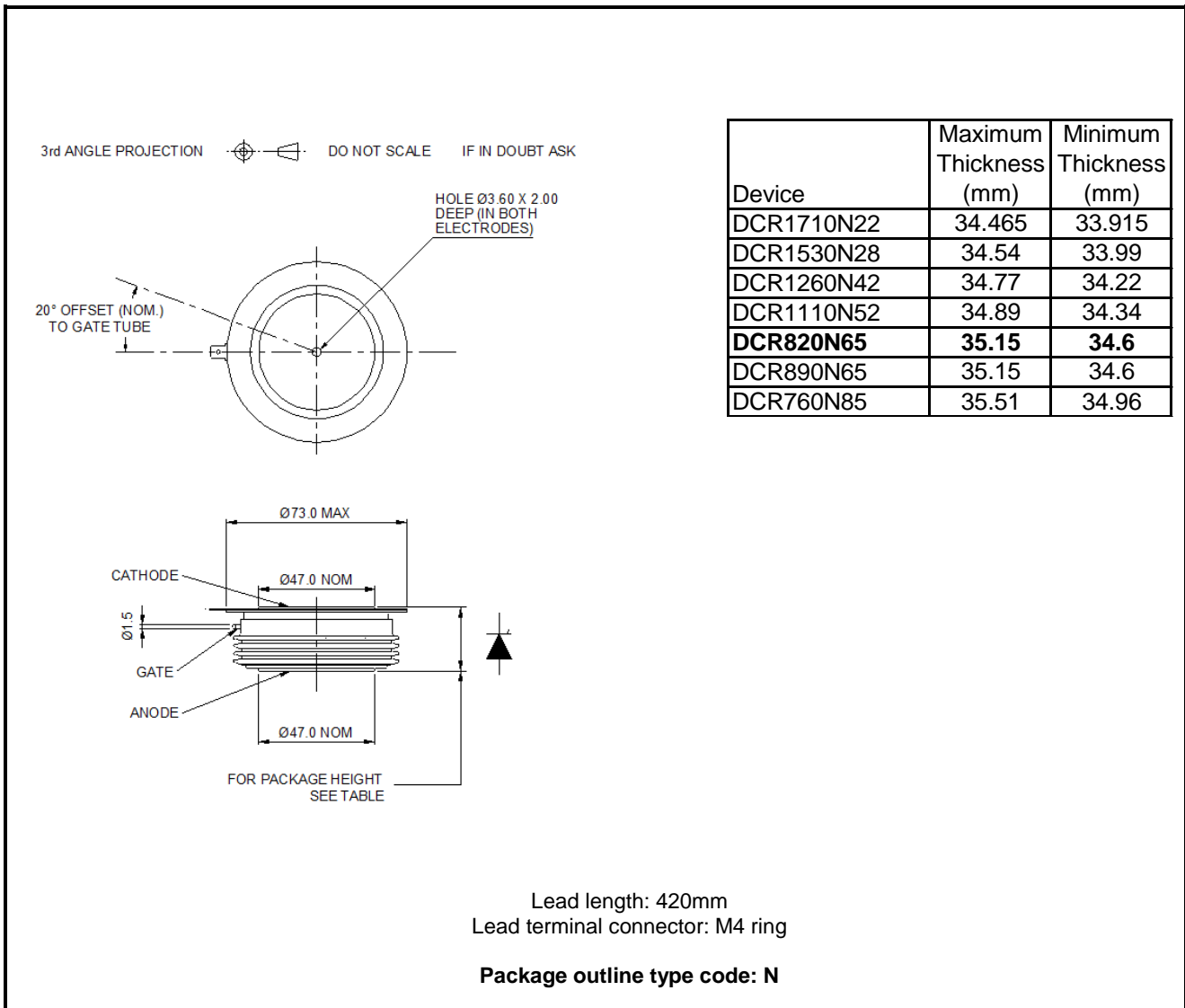



**Fig.16 Turn-off time**

**PACKAGE DETAILS**

For further package information, please contact Customer Services. All dimensions in mm, unless stated otherwise. DO NOT SCALE.

**Fig.17 Package outline**

**IMPORTANT INFORMATION:**

This publication is provided for information only and not for resale.

The products and information in this publication are intended for use by appropriately trained technical personnel.

Due to the diversity of product applications, the information contained herein is provided as a general guide only and does not constitute any guarantee of suitability for use in a specific application. The user must evaluate the suitability of the product and the completeness of the product data for the application. The user is responsible for product selection and ensuring all safety and any warning requirements are met. Should additional product information be needed please contact Customer Service.

Although we have endeavoured to carefully compile the information in this publication it may contain inaccuracies or typographical errors. The information is provided without any warranty or guarantee of any kind.

This publication is an uncontrolled document and is subject to change without notice. When referring to it please ensure that it is the most up to date version and has not been superseded.

The products are not intended for use in applications where a failure or malfunction may cause loss of life, injury or damage to property. The user must ensure that appropriate safety precautions are taken to prevent or mitigate the consequences of a product failure or malfunction.

The products must not be touched when operating because there is a danger of electrocution or severe burning. Always use protective safety equipment such as appropriate shields for the product and wear safety glasses. Even when disconnected any electric charge remaining in the product must be discharged and allowed to cool before safe handling using protective gloves.

Extended exposure to conditions outside the product ratings may affect reliability leading to premature product failure. Use outside the product ratings is likely to cause permanent damage to the product. In extreme conditions, as with all semiconductors, this may include potentially hazardous rupture, a large current to flow or high voltage arcing, resulting in fire or explosion. Appropriate application design and safety precautions should always be followed to protect persons and property.

**Product Status & Product Ordering:**

We annotate datasheets in the top right hand corner of the front page, to indicate product status if it is not yet fully approved for production. The annotations are as follows:-

<b>Target Information:</b>	This is the most tentative form of information and represents a very preliminary specification. No actual design work on the product has been started.
<b>Preliminary Information:</b>	The product design is complete and final characterisation for volume production is in progress. The datasheet represents the product as it is now understood but details may change.
<b>No Annotation:</b>	The product has been approved for production and unless otherwise notified by Dynex any product ordered will be supplied to the <b>current version of the data sheet prevailing at the time of our order acknowledgement.</b>

All products and materials are sold and services provided subject to Dynex's conditions of sale, which are available on request.

Any brand names and product names used in this publication are trademarks, registered trademarks or trade names of their respective owners.

**HEADQUARTERS OPERATIONS**

DYNEX SEMICONDUCTOR LIMITED  
Doddington Road, Lincoln, Lincolnshire, LN6 3LF  
United Kingdom.  
Phone: +44 (0) 1522 500500  
Fax: +44 (0) 1522 500550  
Web: <http://www.dynexsemi.com>

**CUSTOMER SERVICE**

Phone: +44 (0) 1522 502753 / 502901  
Fax: +44 (0) 1522 500020  
e-mail: [power\\_solutions@dynexsemi.com](mailto:power_solutions@dynexsemi.com)