

FEATURES

- 10µs Short Circuit Withstand
- Non Punch Through Silicon
- Isolated Cu Base with Al₂O₃ Substrates
- Lead Free construction

APPLICATIONS

- Motor Controllers
- Traction Drives

The Powerline range of high power modules includes half bridge, chopper, dual, single and bi-directional switch configurations covering voltages from 1200V to 6500V and currents up to 2400A.

The DIM1800ESS12-A000 is a single switch 1200V, n-channel enhancement mode, insulated gate bipolar transistor (IGBT) module. The IGBT has a wide reverse bias safe operating area (RBSOA) plus 10µs short circuit withstand. This device is optimised for traction drives and other applications requiring high thermal cycling capability.

The module incorporates an electrically isolated base plate and low inductance construction enabling circuit designers to optimise circuit layouts and utilise grounded heat sinks for safety.

ORDERING INFORMATION

Order As:

DIM1800ESS12-A000

Note: When ordering, please use the complete part number

KEY PARAMETERS

V_{CES}	1200V
$V_{CE(sat)}$ * (typ)	2.2V
I_C (max)	1800A
$I_{C(PK)}$ (max)	3600A

* Measured at the power busbars, not the auxiliary terminals

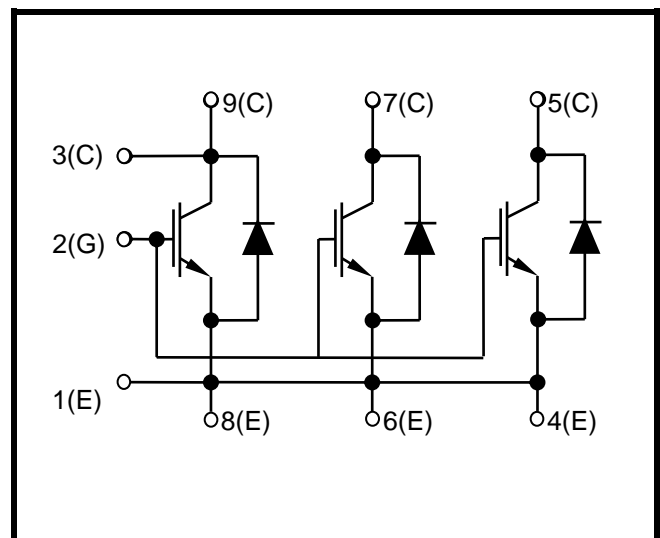
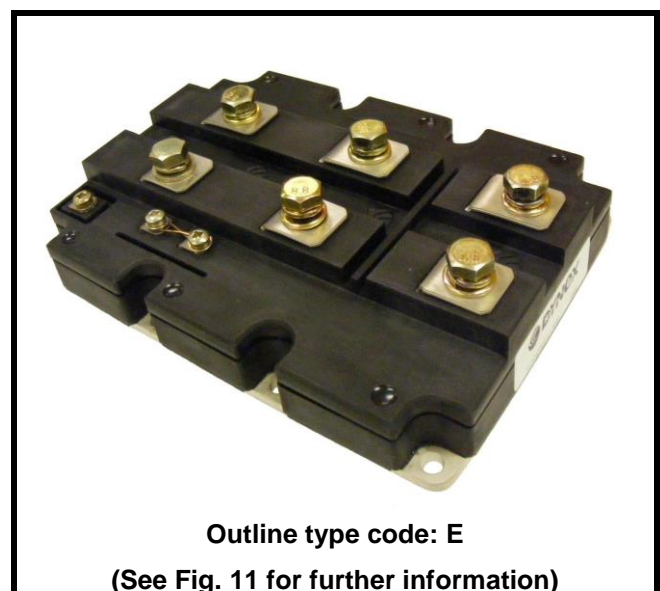

Fig. 1 Circuit configuration



Outline type code: E

(See Fig. 11 for further information)

Fig. 2 Package

ABSOLUTE MAXIMUM RATINGS

Stresses above those listed under ‘Absolute Maximum Ratings’ may cause permanent damage to the device. In extreme conditions, as with all semiconductors, this may include potentially hazardous rupture of the package. Appropriate safety precautions should always be followed. Exposure to Absolute Maximum Ratings may affect device reliability.

T_{case} = 25°C unless stated otherwise

Symbol	Parameter	Test Conditions	Max.	Units
V _{CES}	Collector-emitter voltage	V _{GE} = 0V	1200	V
V _{GES}	Gate-emitter voltage		±20	V
I _C	Continuous collector current	T _{case} = 85°C	1800	A
I _{C(PK)}	Peak collector current	1ms, T _{case} = 115°C	3600	A
P _{max}	Max. transistor power dissipation	T _{case} = 25°C, T _j = 150°C	15625	W
I ² t	Diode I ² t value	V _R = 0, t _p = 10ms, T _j = 125°C	900	kA ² s
V _{isol}	Isolation voltage – per module	Commoned terminals to base plate. AC RMS, 1 min, 50Hz	2500	V

THERMAL AND MECHANICAL RATINGS

Internal insulation material: Al₂O₃
 Baseplate material: Cu
 Creepage distance: 33mm
 Clearance: 20mm
 CTI (Comparative Tracking Index): >600

Symbol	Parameter	Test Conditions	Min	Typ.	Max	Units
R _{th(j-c)}	Thermal resistance – transistor	Continuous dissipation - junction to case	-	-	8	°C/kW
R _{th(j-c)}	Thermal resistance – diode	Continuous dissipation - junction to case	-	-	13	°C/kW
R _{th(c-h)}	Thermal resistance – case to heatsink (per module)	Mounting torque 5Nm (with mounting grease)	-	-	6	°C/kW
T _j	Junction temperature	Transistor	-	-	150	°C
		Diode	-	-	125	°C
T _{stg}	Storage temperature range	-	-40	-	125	°C
	Screw torque	Mounting – M6	-	-	5	Nm
		Electrical connections – M4	-	-	2	Nm
		Electrical connections – M8	-	-	10	Nm

ELECTRICAL CHARACTERISTICS

T_{case} = 25°C unless stated otherwise.

Symbol	Parameter	Test Conditions	Min	Typ	Max	Units
I _{CES}	Collector cut-off current	V _{GE} = 0V, V _{CE} = V _{CES}			3	mA
		V _{GE} = 0V, V _{CE} = V _{CES} , T _{case} = 125°C			75	mA
I _{GES}	Gate leakage current	V _{GE} = ± 20V, V _{CE} = 0V			12	µA
V _{GE(TH)}	Gate threshold voltage	I _C = 90mA, V _{GE} = V _{CE}	4.5	5.5	6.5	V
V _{CE(sat)}	Collector-emitter saturation voltage	V _{GE} = 15V, I _C = 1800A		2.2	2.8	V
		V _{GE} = 15V, I _C = 1800A, T _j = 125°C		2.6	3.3	V
I _F	Diode forward current	DC			1800	A
I _{FM}	Diode maximum forward current	t _p = 1ms			3600	A
V _F	Diode forward voltage	I _F = 1800A		1.9	2.1	V
		I _F = 1800A, T _j = 125°C		1.8	2.1	V
C _{ies}	Input capacitance	V _{CE} = 25V, V _{GE} = 0V, f = 1MHz		200		nF
Q _g	Gate charge	±15V		20		µC
C _{res}	Reverse transfer capacitance	V _{CE} = 25V, V _{GE} = 0V, f = 1MHz				nF
L _M	Module inductance			10		nH
R _{INT}	Internal transistor resistance			90		µΩ
SC _{Data}	Short circuit current, I _{SC}	T _j = 125°C, V _{CC} = 900V t _p ≤ 10µs, V _{GE} ≤ 15V V _{CE(max)} = V _{CES} - L* x dl/dt IEC 60747-9		10000		A

Note:

* L is the circuit inductance + L_M

ELECTRICAL CHARACTERISTICS

T_{case} = 25°C unless stated otherwise

Symbol	Parameter	Test Conditions	Min	Typ.	Max	Units	
t _{d(off)}	Turn-off delay time	I _C = 1800A V _{GE} = ±15V V _{CE} = 600V R _{G(ON)} = 1.2Ω R _{G(OFF)} = 1.2Ω L _S ~ 60nH		1250		ns	
t _f	Fall time			190		ns	
E _{OFF}	Turn-off energy loss				330		mJ
t _{d(on)}	Turn-on delay time				220		ns
t _r	Rise time				200		ns
E _{ON}	Turn-on energy loss				100		mJ
Q _{rr}	Diode reverse recovery charge	I _F = 1800A V _{CE} = 600V di _F /dt = 9000A/μs		210		μC	
I _{rr}	Diode reverse recovery current				860		A
E _{rec}	Diode reverse recovery energy				110		mJ

T_{case} = 125°C unless stated otherwise

Symbol	Parameter	Test Conditions	Min	Typ.	Max	Units	
t _{d(off)}	Turn-off delay time	I _C = 1200A V _{GE} = ±15V V _{CE} = 600V R _{G(ON)} = 1.2Ω R _{G(OFF)} = 1.2Ω L _S ~ 60nH		1450		ns	
t _f	Fall time				190		ns
E _{OFF}	Turn-off energy loss				390		mJ
t _{d(on)}	Turn-on delay time				230		ns
t _r	Rise time				340		ns
E _{ON}	Turn-on energy loss				180		mJ
Q _{rr}	Diode reverse recovery charge	I _F = 1800A V _{CE} = 600V di _F /dt = 8000A/μs		390		μC	
I _{rr}	Diode reverse recovery current				1100		A
E _{rec}	Diode reverse recovery energy				200		mJ

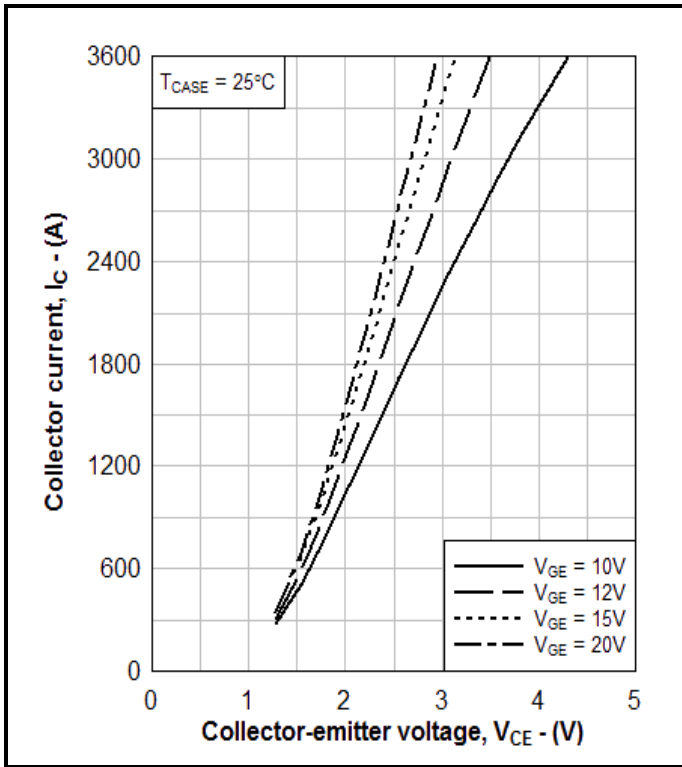

Fig. 3 Typical output characteristics

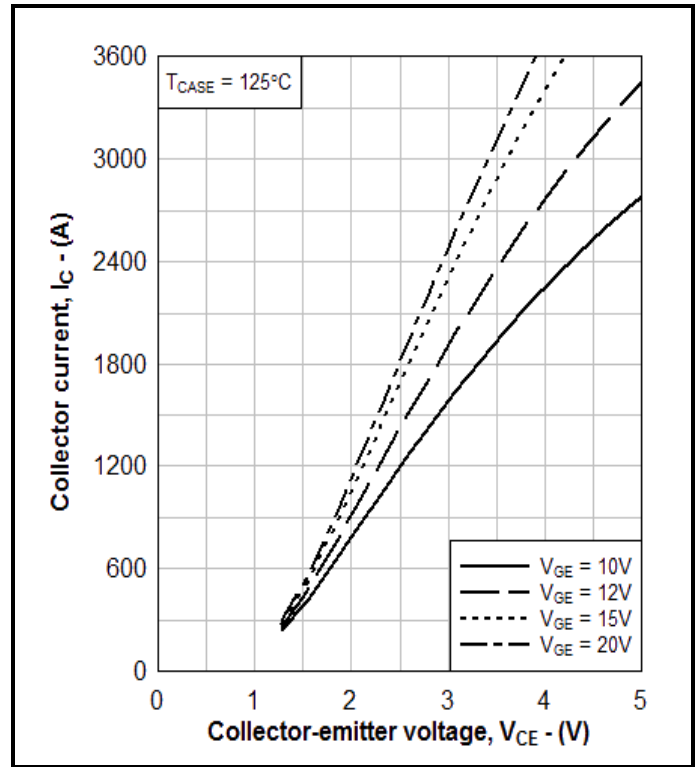

Fig. 4 Typical output characteristics

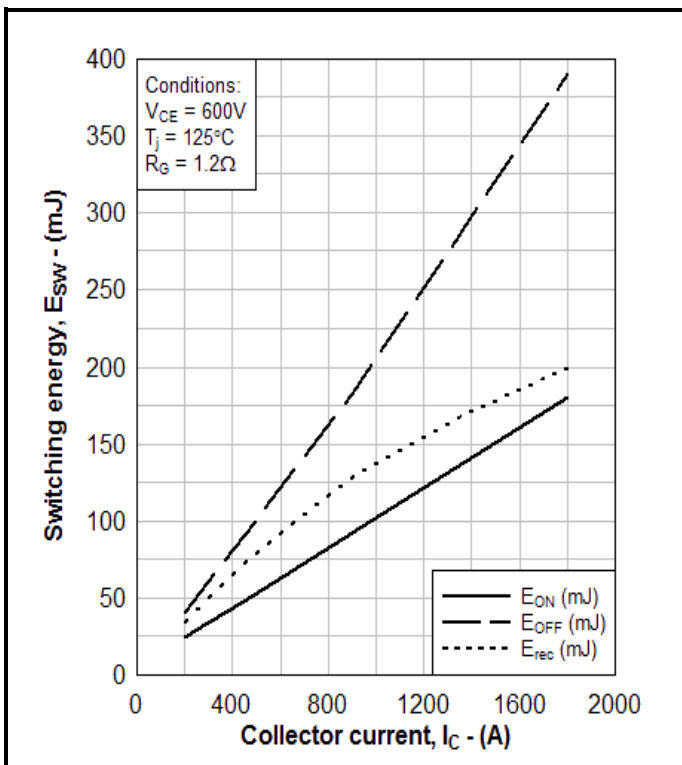

Fig. 5 Typical switching energy vs collector current

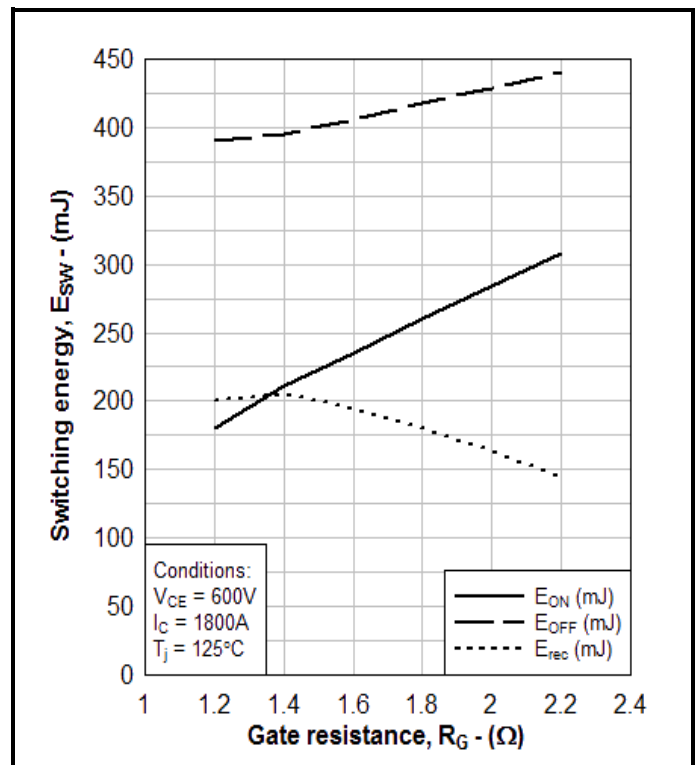

Fig. 6 Typical switching energy vs gate resistance

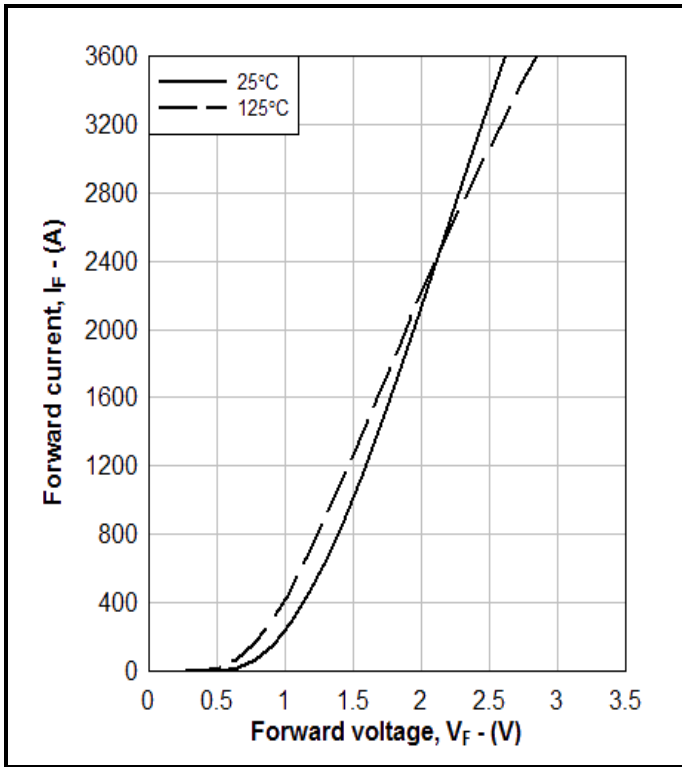

Fig. 7 Diode typical forward characteristics

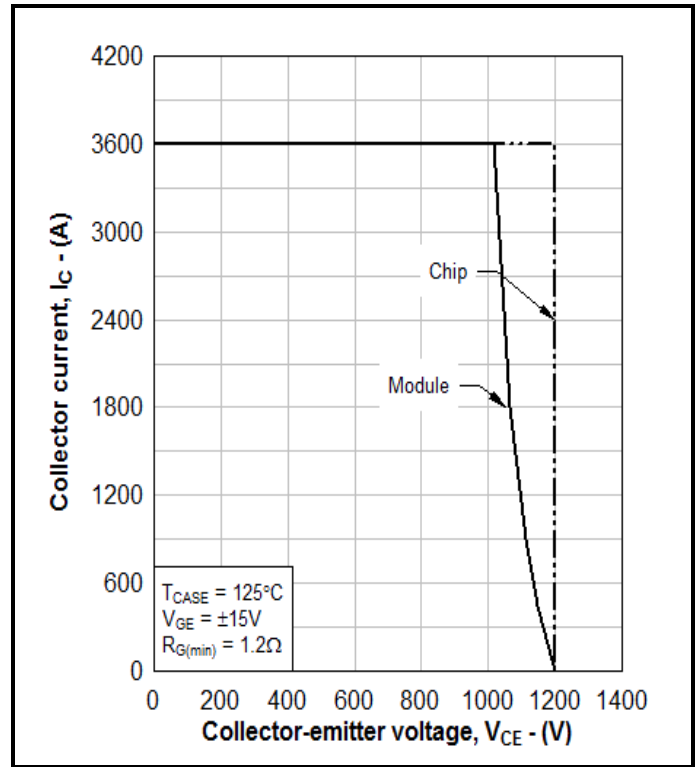

Fig. 8 Reverse bias safe operating area

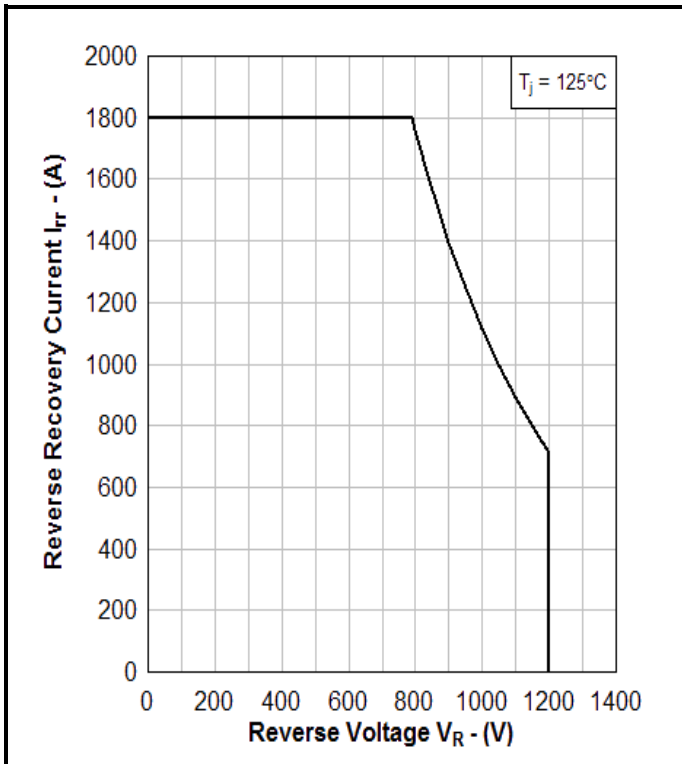

Fig. 9 Diode reverse bias safe operating area

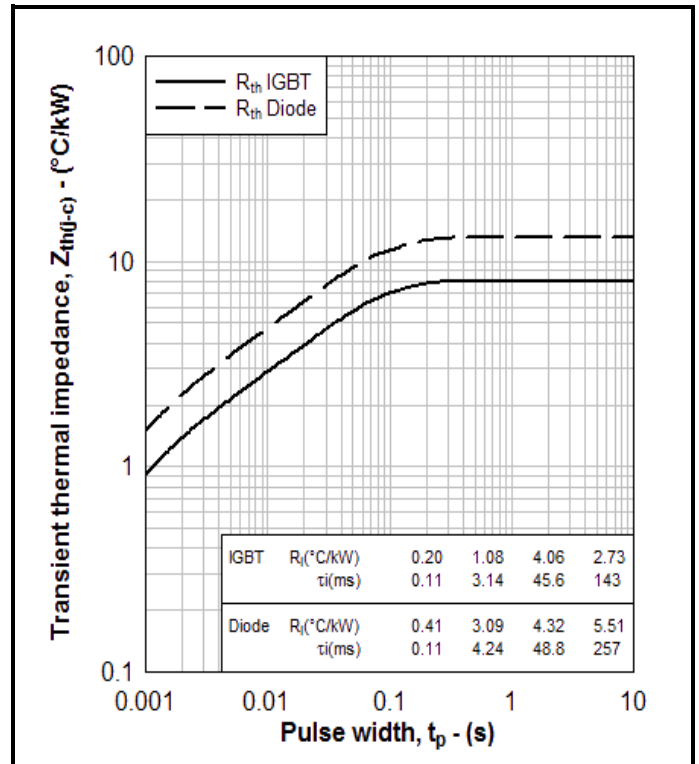

Fig. 10 Transient thermal impedance

IMPORTANT INFORMATION:

This publication is provided for information only and not for resale.

The products and information in this publication are intended for use by appropriately trained technical personnel.

Due to the diversity of product applications, the information contained herein is provided as a general guide only and does not constitute any guarantee of suitability for use in a specific application. The user must evaluate the suitability of the product and the completeness of the product data for the application. The user is responsible for product selection and ensuring all safety and any warning requirements are met. Should additional product information be needed please contact Customer Service.

Although we have endeavoured to carefully compile the information in this publication it may contain inaccuracies or typographical errors. The information is provided without any warranty or guarantee of any kind.

This publication is an uncontrolled document and is subject to change without notice. When referring to it please ensure that it is the most up to date version and has not been superseded.

The products are not intended for use in applications where a failure or malfunction may cause loss of life, injury or damage to property. The user must ensure that appropriate safety precautions are taken to prevent or mitigate the consequences of a product failure or malfunction.

The products must not be touched when operating because there is a danger of electrocution or severe burning. Always use protective safety equipment such as appropriate shields for the product and wear safety glasses. Even when disconnected any electric charge remaining in the product must be discharged and allowed to cool before safe handling using protective gloves.

Extended exposure to conditions outside the product ratings may affect reliability leading to premature product failure. Use outside the product ratings is likely to cause permanent damage to the product. In extreme conditions, as with all semiconductors, this may include potentially hazardous rupture, a large current to flow or high voltage arcing, resulting in fire or explosion. Appropriate application design and safety precautions should always be followed to protect persons and property.

Product Status & Product Ordering:

We annotate datasheets in the top right hand corner of the front page, to indicate product status if it is not yet fully approved for production. The annotations are as follows:-

- Target Information:** This is the most tentative form of information and represents a very preliminary specification. No actual design work on the product has been started.
- Preliminary Information:** The product design is complete and final characterisation for volume production is in progress. The datasheet represents the product as it is now understood but details may change.
- No Annotation:** The product has been approved for production and unless otherwise notified by Dynex any product ordered will be supplied to the **current version of the data sheet prevailing at the time of our order acknowledgement.**

All products and materials are sold and services provided subject to Dynex's conditions of sale, which are available on request.

Any brand names and product names used in this publication are trademarks, registered trademarks or trade names of their respective owners.

HEADQUARTERS OPERATIONS

DYNEX SEMICONDUCTOR LTD

Doddington Road, Lincoln, Lincolnshire, LN6 3LF,
United Kingdom

Fax: +44(0)1522 500550

Tel: +44(0)1522 500500

Web: <http://www.dynexsemi.com>

CUSTOMER SERVICE

DYNEX SEMICONDUCTOR LTD

Doddington Road, Lincoln, Lincolnshire, LN6 3LF,
United Kingdom

Tel: +44(0)1522 502753 / 502901

Email: powersolutions@dynexsemi.com