

### FEATURES

- 10µs Short Circuit Withstand
- Soft Punch Through Silicon
- Isolated AISiC Base with AlN substrates
- High thermal cycling capability

### APPLICATIONS

- Choppers
- Motor Controllers
- Power Supplies
- Traction Auxiliaries

The Powerline range of high power modules includes half bridge, chopper, dual, single and bi-directional switch configurations covering voltages from 600V to 3300V and currents up to 2400A.

The DIM200PLM33-F000 is a 3300V, n channel enhancement mode, insulated gate bipolar transistor (IGBT) chopper module configured with the lower arm of the bridge controlled. The IGBT has a wide reverse bias safe operating area (RBSOA) plus full 10µs short circuit withstand. This device is optimised for traction drives and other applications requiring high thermal cycling capability.

The module incorporates an electrically isolated base plate and low inductance construction enabling circuit designers to optimise circuit layouts and utilise grounded heat sinks for safety.

### ORDERING INFORMATION

Order As:

**DIM200PLM33-F000**

Note: When ordering, please use the whole part number.

### KEY PARAMETERS

$V_{CES}$		<b>3300V</b>
$V_{CE(sat)}$	<b>(typ)</b>	<b>2.8V</b>
$I_C$	<b>(max)</b>	<b>200A</b>
$I_{C(PK)}$	<b>(max)</b>	<b>400A</b>

(measured at the power busbars and not the auxiliary terminals)

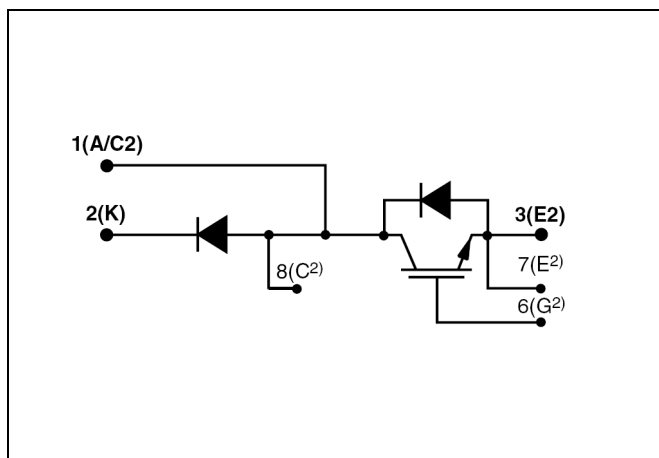

Fig. 1 Chopper circuit diagram



Fig. 2 Electrical connections (not to scale)

**ABSOLUTE MAXIMUM RATINGS - PER ARM**

Stresses above those listed under ‘Absolute Maximum Ratings’ may cause permanent damage to the device. In extreme conditions, as with all semiconductors, this may include potentially hazardous rupture of the package. Appropriate safety precautions should always be followed. Exposure to Absolute Maximum Ratings may affect device reliability.

**T<sub>case</sub> = 25° C unless stated otherwise**

Symbol	Parameter	Test Conditions	Max.	Units
V <sub>CES</sub>	Collector-emitter voltage	V <sub>GE</sub> = 0V	3300	V
V <sub>GES</sub>	Gate-emitter voltage		±20	V
I <sub>C</sub>	Continuous collector current	T <sub>case</sub> = 90° C	200	A
I <sub>C(PK)</sub>	Peak collector current	1ms, T <sub>case</sub> = 115° C	400	A
P <sub>max</sub>	Max. transistor power dissipation	T <sub>case</sub> = 25° C, T <sub>j</sub> = 150° C	2.6	W
I <sup>2</sup> t	Diode I <sup>2</sup> t value (IGBT arm)	V <sub>R</sub> = 0, t <sub>p</sub> = 10ms, T <sub>vj</sub> = 125° C	20	kA <sup>2</sup> S
	Diode I <sup>2</sup> t value (Diode arm)		20	
V <sub>isol</sub>	Isolation voltage – per module	Commoned terminals to base plate. AC RMS, 1 min, 50Hz	6000	V
Q <sub>PD</sub>	Partial discharge - per module	IEC1287. V <sub>1</sub> = 3500V, V <sub>2</sub> = 2600V, 50Hz RMS	10	pC

**THERMAL AND MECHANICAL RATINGS**

Internal insulation material: AIN  
 Baseplate material: AISiC  
 Creepage distance: 33mm  
 Clearance: 20mm  
 CTI (Critical Tracking Index): 350

Symbol	Parameter	Test Conditions	Min.	Typ.	Max.	Units
$R_{th(j-c)}$	Thermal resistance - transistor	Continuous dissipation – junction to case	-	-	48	°C/kW
$R_{th(j-c)}$	Thermal resistance – diode (IGBT arm)	Continuous dissipation – junction to case	-	-	96	°C/kW
	Thermal resistance- diode ( Diode arm)				96	°C/kW
$R_{th(c-h)}$	Thermal resistance – case to heatsink (per module)	Mounting torque 5Nm (with mounting grease)	-	-	16	°C/kW
$T_j$	Junction temperature	Transistor	-	-	150	°C
		Diode	-	-	125	°C
$T_{stg}$	Storage temperature range	-	-40	-	125	°C
-	Screw torque	Mounting – M6	-	-	5	Nm
		Electrical connections – M5	-	-	4	Nm

**ELECTRICAL CHARACTERISTICS**
**T<sub>case</sub> = 25°C unless stated otherwise.**

Symbol	Parameter	Test Conditions	Min.	Typ.	Max.	Units	
I <sub>ces</sub>	Collector cut-off current	V <sub>GE</sub> = 0V, V <sub>CE</sub> = V <sub>CES</sub>	-	-	1	mA	
		V <sub>GE</sub> = 0V, V <sub>CE</sub> = V <sub>CES</sub> , T <sub>case</sub> = 125°C	-	-	15	mA	
I <sub>ces</sub>	Gate leakage current	V <sub>GE</sub> = ±20V, V <sub>CE</sub> = 0V	-	-	1	µA	
V <sub>GE(TH)</sub>	Gate threshold voltage	I <sub>C</sub> = 40mA, V <sub>GE</sub> = V <sub>CE</sub>	5.5	6.5	7.0	V	
V <sub>CE(sat)†</sub>	Collector-emitter saturation voltage	V <sub>GE</sub> = 15V, I <sub>C</sub> = 200A	-	2.8	-	V	
		V <sub>GE</sub> = 15V, I <sub>C</sub> = 200A, T <sub>case</sub> = 125°C	-	3.6	-	V	
I <sub>F</sub>	Diode forward current	DC	-	-	200	A	
I <sub>FM</sub>	Diode maximum forward current	t <sub>p</sub> = 1ms	-	-	400	A	
V <sub>F†</sub>	Diode forward voltage (IGBT arm)	I <sub>F</sub> = 200A	-	2.9	-	V	
	Diode forward voltage (Diode arm)		-	2.9	-	V	
	Diode forward voltage (IGBT arm)	I <sub>F</sub> = 200A, T <sub>case</sub> = 125°C	-	3.0	-	V	
	Diode forward voltage (Diode arm)		-	3.0	-	V	
C <sub>ies</sub>	Input capacitance	V <sub>CE</sub> = 25V, V <sub>GE</sub> = 0V, f = 1MHz	-	36	-	nF	
L <sub>M</sub>	Module inductance – per arm	-	-	40	-	nH	
R <sub>INT</sub>	Internal resistance – per arm	-	-	0.5	-	mΩ	
SC <sub>Data</sub>	Short circuit. I <sub>sc</sub>	T <sub>j</sub> = 125°C, V <sub>cc</sub> = 2500V, t <sub>p</sub> ≤ 10µs, V <sub>CE(max)</sub> = V <sub>CES</sub> - L* <i>x</i> di/dt IEC 60747-9	I <sub>1</sub>	-	1000	-	A
			I <sub>2</sub>	-	930	-	A

**Note:**

† Measured at the power busbars and not the auxiliary terminals

 \* L is the circuit inductance + L<sub>M</sub>

**ELECTRICAL CHARACTERISTICS**
**T<sub>case</sub> = 25°C unless stated otherwise.**

Symbol	Parameter	Test Conditions	Min.	Typ.	Max.	Units
t <sub>d(off)</sub>	Turn-off delay time	I <sub>C</sub> = 200A V <sub>GE</sub> = ±15V V <sub>CE</sub> = 1800V R <sub>G(ON)</sub> = R <sub>G(OFF)</sub> = 16.5Ω L ~ 100nH C <sub>ge</sub> = 56nF	-	1950	-	ns
t <sub>f</sub>	Fall time		-	170	-	ns
E <sub>OFF</sub>	Turn-off energy loss		-	220	-	mJ
t <sub>d(on)</sub>	Turn-on delay time		-	1180	-	ns
t <sub>r</sub>	Rise time		-	225	-	ns
Q <sub>g</sub>	Gate charge		-	5	-	μC
E <sub>ON</sub>	Turn-on energy loss		R <sub>G(ON)</sub> = 7.5Ω	-	290	-
Q <sub>rr</sub>	Diode reverse recovery charge	I <sub>F</sub> = 200A, V <sub>R</sub> = 1800V, dI <sub>F</sub> /dt = 1600A/μs	-	80	-	μC
I <sub>rr</sub>	Diode reverse current		-	144	-	A
E <sub>REC</sub>	Diode reverse recovery energy		Diode arm	-	75	-

**T<sub>case</sub> = 125°C unless stated otherwise.**

Symbol	Parameter	Test Conditions	Min.	Typ.	Max.	Units	
t <sub>d(off)</sub>	Turn-off delay time	I <sub>C</sub> = 200A V <sub>GE</sub> = ±15V V <sub>CE</sub> = 1800V R <sub>G(ON)</sub> = R <sub>G(OFF)</sub> = 16.5Ω L ~ 100nH, C <sub>ge</sub> = 56nF	-	2200	-	ns	
t <sub>f</sub>	Fall time		-	190	-	ns	
E <sub>OFF</sub>	Turn-off energy loss		-	265	-	mJ	
t <sub>d(on)</sub>	Turn-on delay time		-	1150	-	ns	
t <sub>r</sub>	Rise time		-	280	-	ns	
E <sub>ON</sub>	Turn-on energy loss		R <sub>G(ON)</sub> = 7.5Ω	-	390	-	mJ
Q <sub>rr</sub>	Diode reverse recovery charge		I <sub>F</sub> = 200A, V <sub>R</sub> = 1800V, dI <sub>F</sub> /dt = 1600A/μs	-	125	-	μC
I <sub>rr</sub>	Diode reverse current	-		155	-	A	
E <sub>REC</sub>	Diode reverse recovery energy	Diode arm		-	130	-	mJ

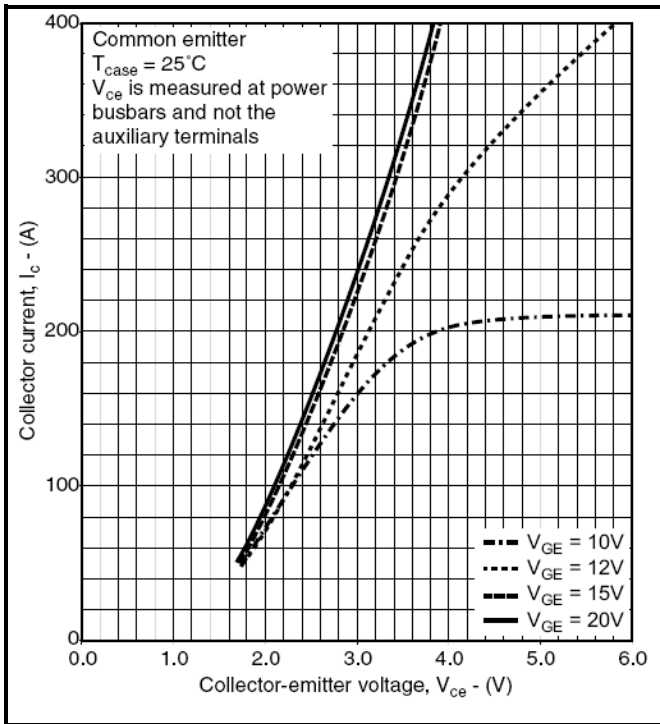

Fig.3 Typical output characteristics

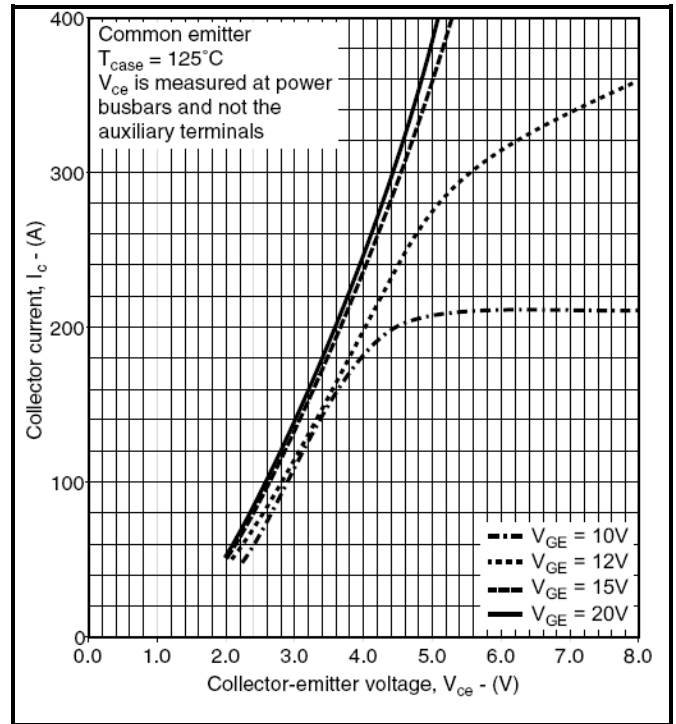

Fig.4 Typical output characteristics

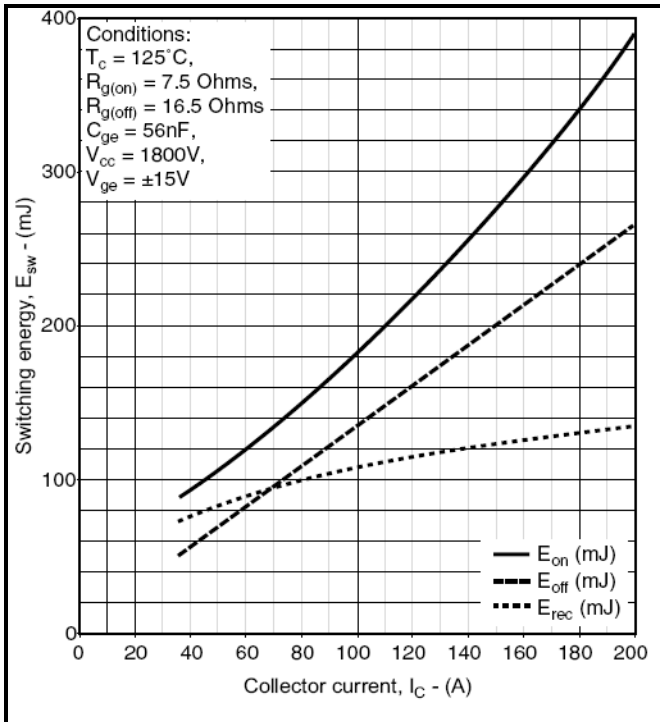

Fig.5 Typical switching energy vs collector current

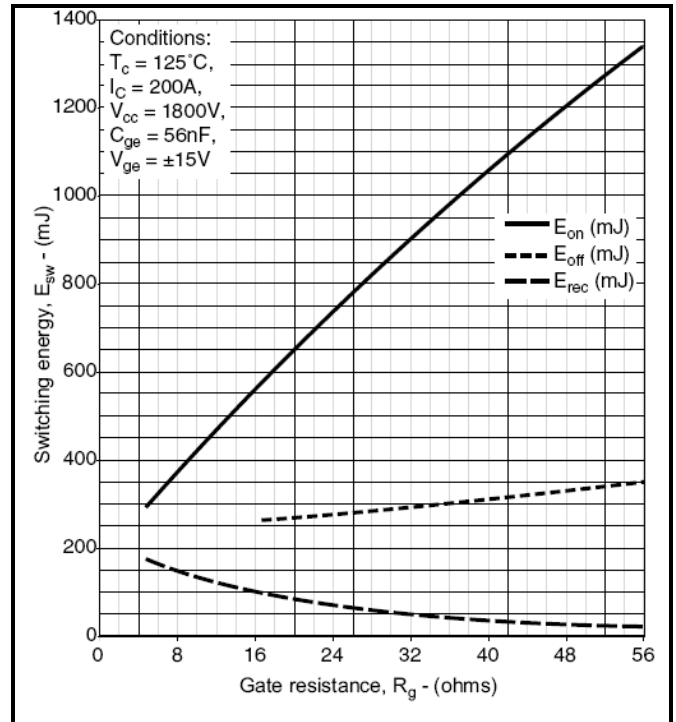

Fig.6 Typical switching energy vs gate resistance

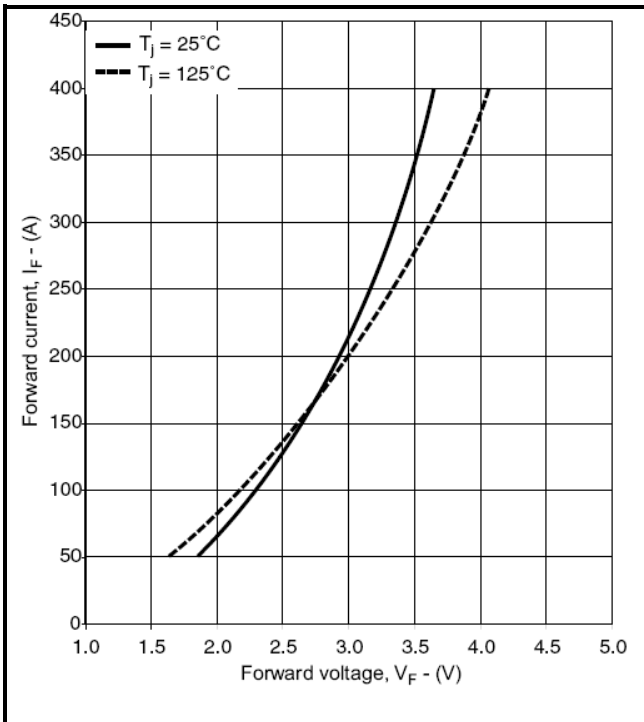

Fig.7 Diode typical forward characteristics

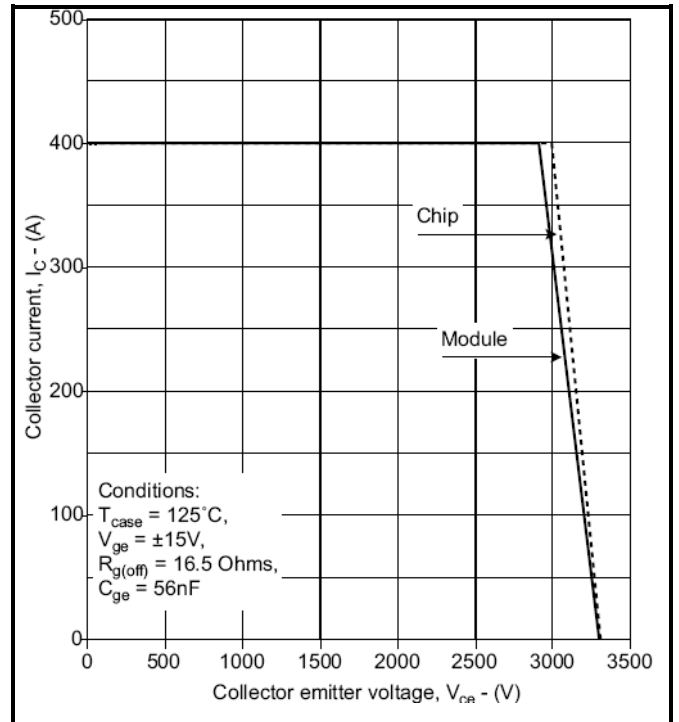

Fig.8 Reverse bias safe operating area

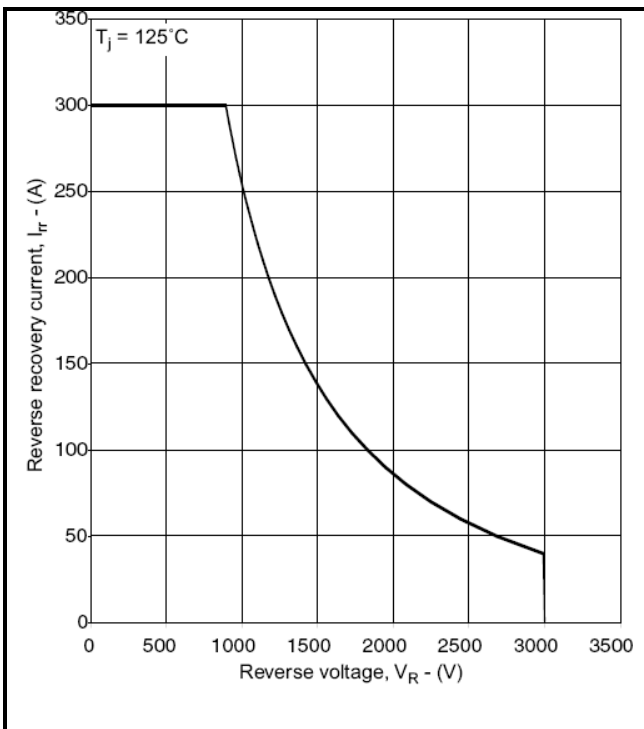

Fig.9 Diode reverse bias safe operating area

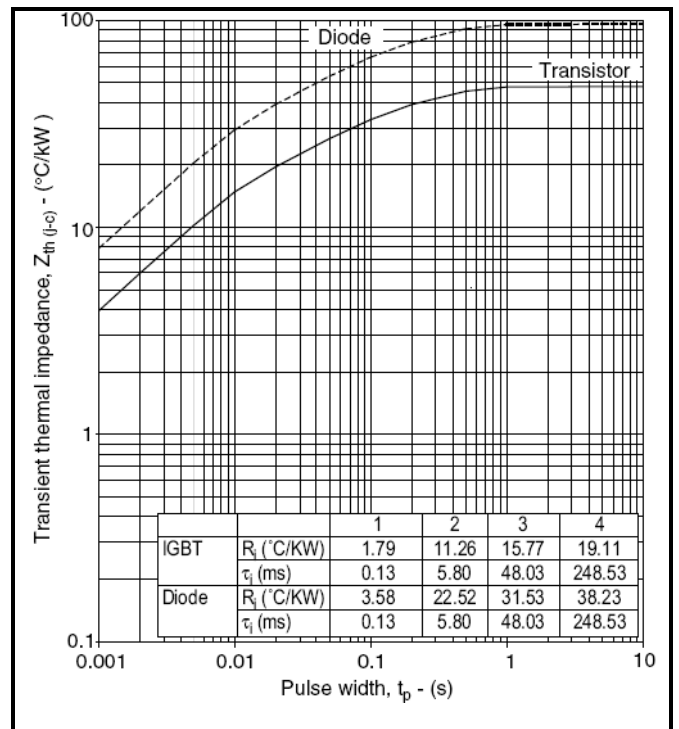
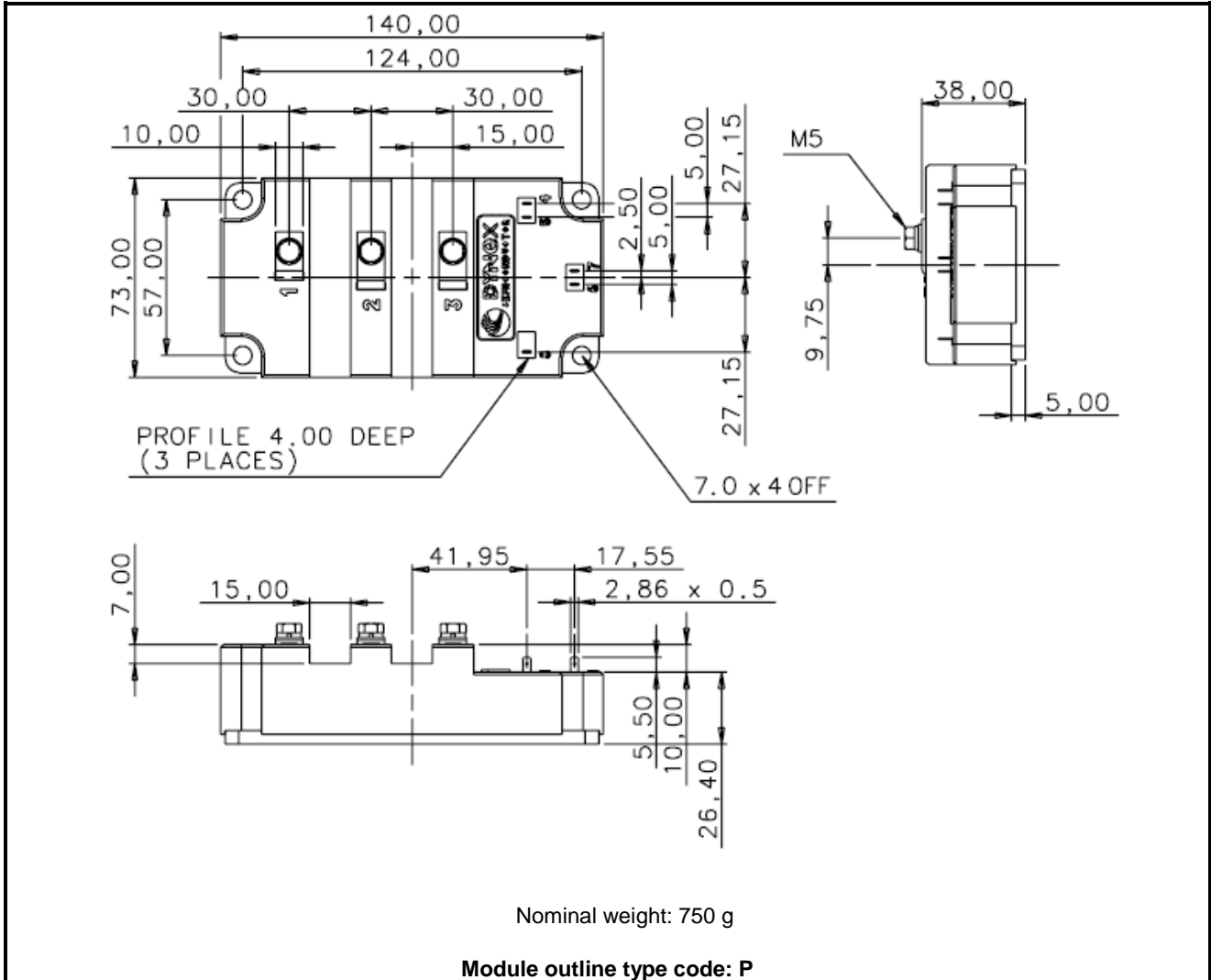

Fig.10 Transient thermal impedance

**PACKAGE DETAILS**

For further package information, please visit our website or contact Customer Services. All dimensions in mm, unless stated otherwise.  
DO NOT SCALE.



## POWER ASSEMBLY CAPABILITY

The Power Assembly group was set up to provide a support service for those customers requiring more than the basic semiconductor, and has developed a flexible range of heatsink and clamping systems in line with advances in device voltages and current capability of our semiconductors.

We offer an extensive range of air and liquid cooled assemblies covering the full range of circuit designs in general use today. The Assembly group offers high quality engineering support dedicated to designing new units to satisfy the growing needs of our customers.

Using the latest CAD methods our team of design and applications engineers aim to provide the Power Assembly Complete Solution (PACs).

## HEATSINKS

The Power Assembly group has its own proprietary range of extruded aluminium heatsinks which have been designed to optimise the performance of Dynex semiconductors. Data with respect to air natural, forced air and liquid cooling (with flow rates) is available on request.

For further information on device clamps, heatsinks and assemblies, please contact your nearest sales representative or Customer Services.



<http://www.dynexsemi.com>

e-mail: [power\\_solutions@dynexsemi.com](mailto:power_solutions@dynexsemi.com)

HEADQUARTERS OPERATIONS  
**DYNEX SEMICONDUCTOR LTD**  
Doddington Road, Lincoln  
Lincolnshire, LN6 3LF. United Kingdom.  
Tel: +44(0)1522 500500  
Fax: +44(0)1522 500550

CUSTOMER SERVICE  
Tel: +44(0)1522 502753 / 502901. Fax: +44(0)1522 500020

© Dynex Semiconductor 2003 TECHNICAL DOCUMENTATION – NOT FOR  
RESALE. PRODUCED IN UNITED KINGDOM.

### Datasheet Annotations:

Dynex Semiconductor annotate datasheets in the top right hand corner of the front page, to indicate product status. The annotations are as follows:-

**Target Information:** This is the most tentative form of information and represents a very preliminary specification. No actual design work on the product has been started.

**Preliminary Information:** The product is in design and development. The datasheet represents the product as it is understood but details may change.

**Advance Information:** The product design is complete and final characterisation for volume production is well in hand.

**No Annotation:** The product parameters are fixed and the product is available to datasheet specification.

This publication is issued to provide information only which (unless agreed by the Company in writing) may not be used, applied or reproduced for any purpose nor form part of any order or contract nor to be regarded as a representation relating to the products or services concerned. No warranty or guarantee express or implied is made regarding the capability, performance or suitability of any product or service. The Company reserves the right to alter without prior notice the specification, design or price of any product or service. Information concerning possible methods of use is provided as a guide only and does not constitute any guarantee that such methods of use will be satisfactory in a specific piece of equipment. It is the user's responsibility to fully determine the performance and suitability of any equipment using such information and to ensure that any publication or data used is up to date and has not been superseded. These products are not suitable for use in any medical products whose failure to perform may result in significant injury or death to the user. All products and materials are sold and services provided subject to the Company's conditions of sale, which are available on request.

All brand names and product names used in this publication are trademarks, registered trademarks or trade names of their respective owners.