



FEATURES

- Low Reverse Recovery Charge
- High Switching Speed
- Low Forward Voltage Drop
- Isolated AISiC Base with AlN substrates
- Low FIT Rate

APPLICATIONS

- Freewheel Diode
- Motor Controllers
- Resonant Converters
- Multi-level Switch Inverters

The DFM400PXM33-F000 is a series pair 3300-volt, fast recovery diode (FRD) module. Designed for low power loss, the module is suitable for a variety of high voltage applications in motor drives and power conversion.

Fast switching times and low reverse recovery losses allow high frequency operation making the device suitable for the latest drive designs employing pwm and high frequency switching.

These modules incorporate electrically isolated base plates and low inductance construction enabling circuit designers to optimise circuit layouts and utilise grounded heat sinks for safety.

ORDERING INFORMATION

Order As:

DFM400PXM33-F000

Note: When ordering, please use the whole part number.

KEY PARAMETERS

| | | |
|-----------|-------|--------------|
| V_{RRM} | | 3300V |
| V_F | (typ) | 2.9V |
| I_F | (max) | 400A |
| I_{FM} | (max) | 800A |

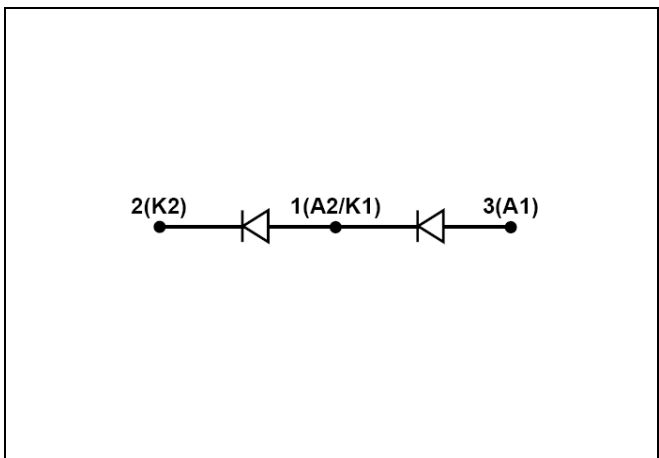

Fig. 1 Circuit diagram

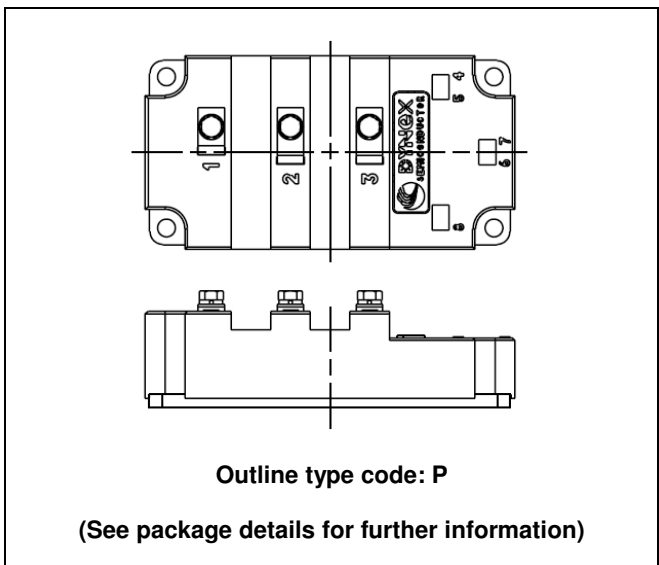

Fig. 2 Electrical connections (not to scale)

ABSOLUTE MAXIMUM RATINGS - PER ARM

Stresses above those listed under 'Absolute Maximum Ratings' may cause permanent damage to the device. In extreme conditions, as with all semiconductors, this may include potentially hazardous rupture of the package. Appropriate safety precautions should always be followed. Exposure to Absolute Maximum Ratings may affect device reliability.

T_{case} = 25° C unless stated otherwise – per Arm

| Symbol | Parameter | Test Conditions | Max. | Units |
|---------------------|--|---|------|-------------------|
| V _{RRM} | Repetitive peak reverse voltage | T _j = 125° C | 3300 | V |
| I _F | Forward current (per arm) | DC, T _{case} = 68° C | 400 | A |
| I _{FM} | Peak diode current | T _{case} = 108° C, t _p = 1ms | 800 | A |
| I ² t | I ² t value fuse current rating | V _R = 0V, t _p = 10ms, T _j = 125° C | 80 | KA ² s |
| P _{max} | Maximum power dissipation | T _{case} = 25° C, T _j = 125° C | 2.08 | kW |
| V _{isol} | Isolation voltage – per module | Commoned terminals to base plate. AC RMS, 1 min, 50Hz | 6 | kV |
| Q _{PD} | Partial discharge - per module | IEC1287. V ₁ = 3500V, V ₂ = 2600V, 50Hz RMS | 10 | pC |
| V _{RRM DC} | DC Voltage stability | 25° C at sea level, 100 FITs | 2200 | V |

THERMAL AND MECHANICAL RATINGS

Internal insulation material: AIN
 Baseplate material: AISiC
 Creepage distance: 33mm
 Clearance: 20mm
 CTI (Critical Tracking Index): 350

| Symbol | Parameter | Test Conditions | Min. | Typ. | Max. | Units |
|----------------------|--|--|------|------|------|-------|
| R _{th(j-c)} | Thermal resistance – diode per arm | Continuous dissipation – junction to case | - | - | 48 | °C/kW |
| R _{th(c-h)} | Thermal resistance – case to heatsink (per module) | Mounting torque 5Nm (with mounting grease) | - | - | 16 | °C/kW |
| T _j | Junction temperature | Diode | -40 | - | 125 | °C |
| T _{stg} | Storage temperature range | - | -40 | - | 125 | °C |
| | Screw torque | Mounting – M6 | - | - | 5 | Nm |
| | | Electrical connections – M5 | - | - | 4 | Nm |

ELECTRICAL CHARACTERISTICS

STATIC ELECTRICAL CHARACTERISTICS – PER ARM

T_{case} = 25° C unless stated otherwise.

| Symbol | Parameter | Test Conditions | Min. | Typ. | Max. | Units |
|-----------------|-------------------------------|---|------|------|------|-------|
| I _{RM} | Peak reverse blocking current | V _R = 3300V, T _j = 125° C | - | - | 30 | mA |
| V _F | Forward voltage | I _F = 400A | - | 2.9 | - | V |
| | | I _F = 400A, T _j = 125° C | - | 3.0 | - | V |
| L | Inductance | - | - | 40 | - | nH |

DYNAMIC ELECTRICAL CHARACTERISTICS – PER ARM

T_{case} = 25° C unless stated otherwise.

| Symbol | Parameter | Test Conditions | Min. | Typ. | Max. | Units |
|------------------|-------------------------------|---|------|------|------|-------|
| I _{rr} | Peak reverse recovery current | I _F = 400A dI _F /dt = 2000A/μs V _R = 1800V | - | 330 | - | A |
| Q _{rr} | Reverse recovery charge | | - | 160 | - | μC |
| E _{rec} | Reverse recovery energy | | - | 150 | - | mJ |

T_{case} = 125° C unless stated otherwise.

| Symbol | Parameter | Test Conditions | Min. | Typ. | Max. | Units |
|------------------|-------------------------------|---|------|------|------|-------|
| I _{rr} | Peak reverse recovery current | I _F = 400A dI _F /dt = 2000A/μs V _R = 1800V | - | 400 | - | A |
| Q _{rr} | Reverse recovery charge | | - | 300 | - | μC |
| E _{rec} | Reverse recovery energy | | - | 300 | - | mJ |

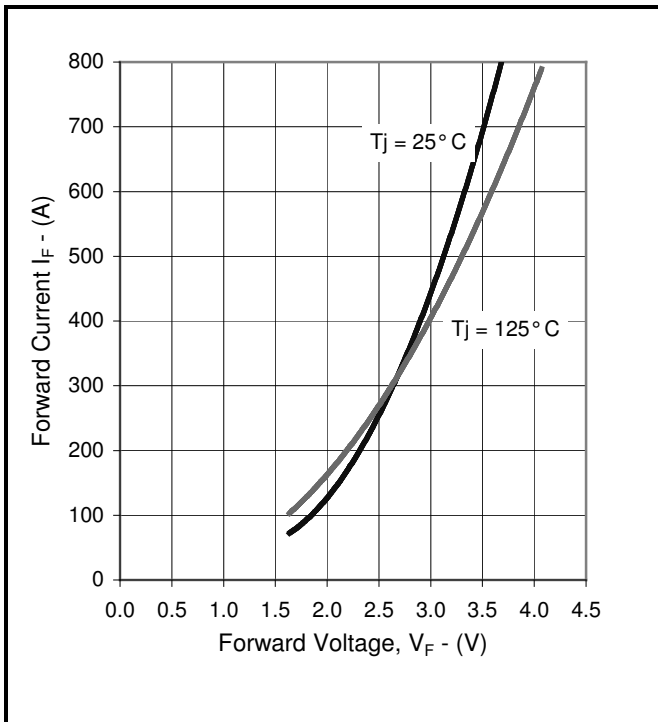

Fig.3 Diode typical forward characteristics

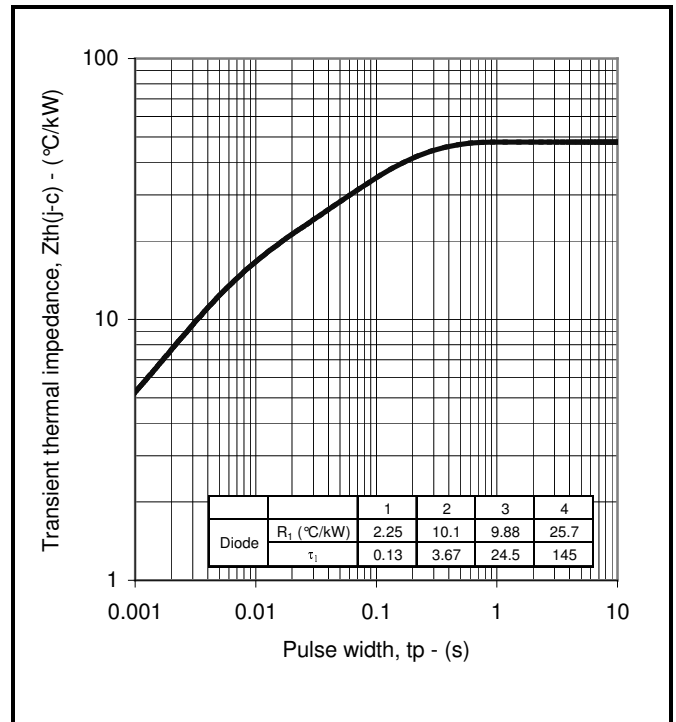

Fig.4 Transient thermal impedance

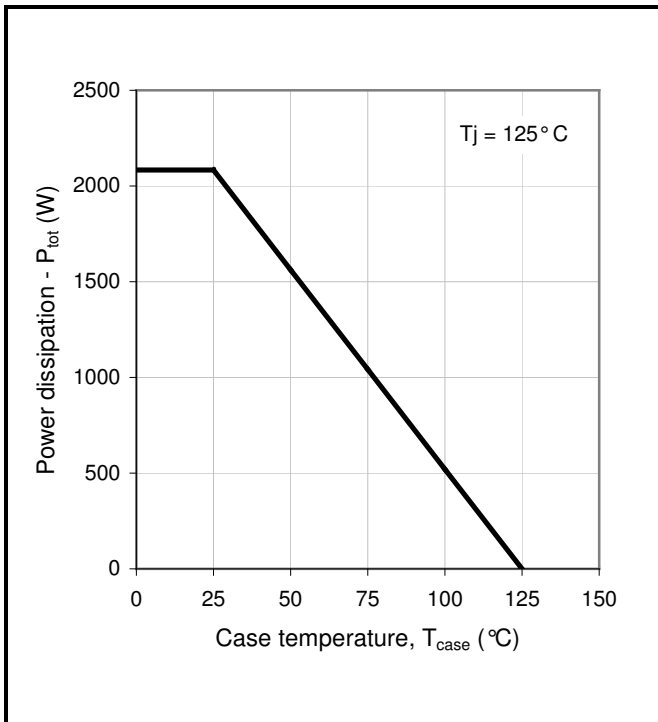

Fig.5 Power dissipation

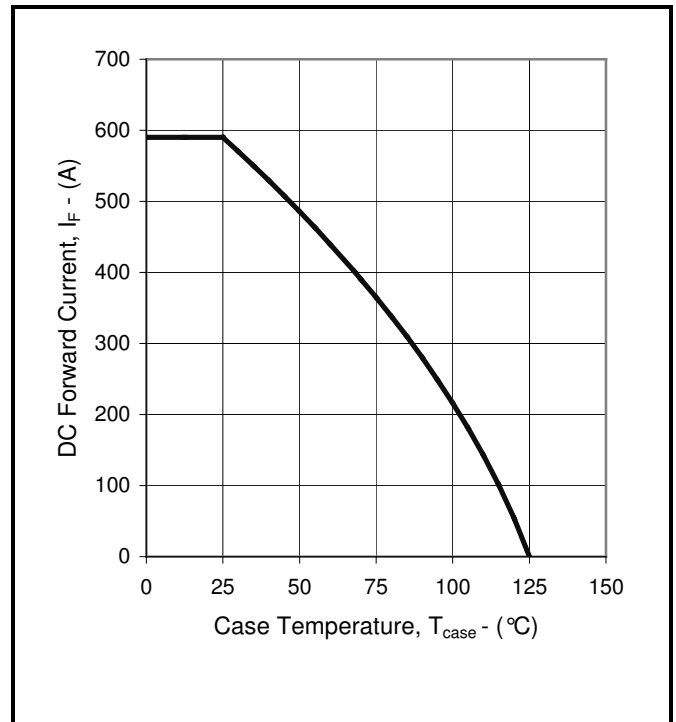

Fig.6 DC current rating vs case temperature

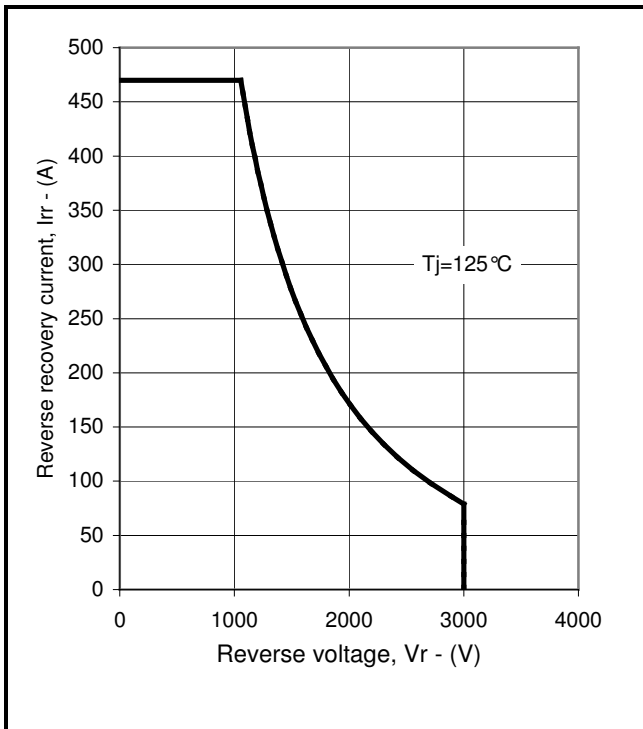
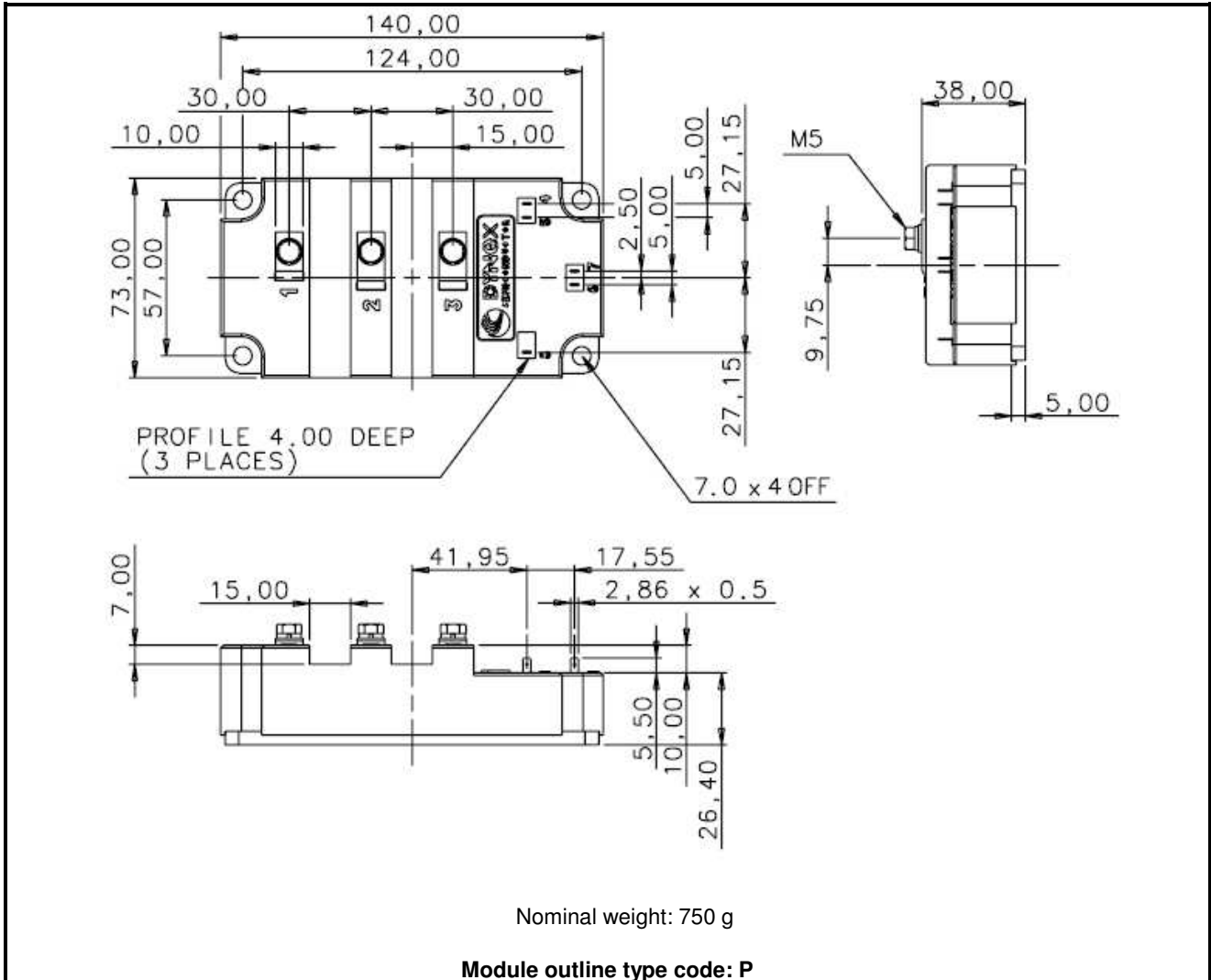

Fig.7 Diode reverse bias safe operating area

PACKAGE DETAILS

For further package information, please visit our website or contact Customer Services. All dimensions in mm, unless stated otherwise.
DO NOT SCALE.



POWER ASSEMBLY CAPABILITY

The Power Assembly group was set up to provide a support service for those customers requiring more than the basic semiconductor, and has developed a flexible range of heatsink and clamping systems in line with advances in device voltages and current capability of our semiconductors.

We offer an extensive range of air and liquid cooled assemblies covering the full range of circuit designs in general use today. The Assembly group offers high quality engineering support dedicated to designing new units to satisfy the growing needs of our customers.

Using the latest CAD methods our team of design and applications engineers aim to provide the Power Assembly Complete Solution (PACs).

HEATSINKS

The Power Assembly group has its own proprietary range of extruded aluminium heatsinks which have been designed to optimise the performance of Dynex semiconductors. Data with respect to air natural, forced air and liquid cooling (with flow rates) is available on request.

For further information on device clamps, heatsinks and assemblies, please contact your nearest sales representative or Customer Services.



<http://www.dynexsemi.com>

e-mail: power_solutions@dynexsemi.com

HEADQUARTERS OPERATIONS
DYNEX SEMICONDUCTOR LTD
Doddington Road, Lincoln
Lincolnshire, LN6 3LF. United Kingdom.
Tel: +44(0)1522 500500
Fax: +44(0)1522 500550

CUSTOMER SERVICE
Tel: +44(0)1522 502753 / 502901. Fax: +44(0)1522 500020

© Dynex Semiconductor 2003 TECHNICAL DOCUMENTATION – NOT FOR RESALE. PRODUCED IN UNITED KINGDOM.

Datasheet Annotations:

Dynex Semiconductor annotate datasheets in the top right hand corner of the front page, to indicate product status. The annotations are as follows:-

Target Information: This is the most tentative form of information and represents a very preliminary specification. No actual design work on the product has been started.

Preliminary Information: The product is in design and development. The datasheet represents the product as it is understood but details may change.

Advance Information: The product design is complete and final characterisation for volume production is well in hand.

No Annotation: The product parameters are fixed and the product is available to datasheet specification.

This publication is issued to provide information only which (unless agreed by the Company in writing) may not be used, applied or reproduced for any purpose nor form part of any order or contract nor to be regarded as a representation relating to the products or services concerned. No warranty or guarantee express or implied is made regarding the capability, performance or suitability of any product or service. The Company reserves the right to alter without prior notice the specification, design or price of any product or service. Information concerning possible methods of use is provided as a guide only and does not constitute any guarantee that such methods of use will be satisfactory in a specific piece of equipment. It is the user's responsibility to fully determine the performance and suitability of any equipment using such information and to ensure that any publication or data used is up to date and has not been superseded. These products are not suitable for use in any medical products whose failure to perform may result in significant injury or death to the user. All products and materials are sold and services provided subject to the Company's conditions of sale, which are available on request.

All brand names and product names used in this publication are trademarks, registered trademarks or trade names of their respective owners.